

Application Manual

Real Time Clock Module

RA-8581SA

Model	Product Number
RA-8581SA	Q41A88151xxxx00

EPSON TOYOCOM CORPORATION

NOTICE

- The material is subject to change without notice.
- Any part of this material may not be reproduced or duplicated in any form or any means without the written permission of Epson Toyocom.
- The information, applied circuit, program, usage etc., written in this material is just for reference. Epson Toyocom does not assume any liability for the occurrence of infringing any patent or copyright of a third party. This material does not authorize the licensing for any patent or intellectual copyrights.
- Any product described in this material may contain technology or the subject relating to strategic products under the control of the Foreign Exchange and Foreign Trade Law of Japan and may require an export licence from the Ministry of International Trade and industry or other approval from another government agency.
- You are requested not to use the products (and any technical information furnished, if any) for the development and/or manufacture of weapon of mass destruction or for other military purposes. You are also requested that you would not make the products available to any third party who may use the products for such prohibited purposes.
- These products are intended for general use in electronic equipment. When using them in specific applications that require extremely high reliability such as applications stated below, it is required to obtain the permission from Epson Toyocom in advance.
 - / Space equipment (artificial satellites, rockets, etc) / Transportation vehicles and related (automobiles, aircraft, trains, vessels, etc) / Medical instruments to sustain life / Submarine transmitters
 - / Power stations and related / Fire work equipment and security equipment / traffic control equipment
 - / and others requiring equivalent reliability.
- In this manual for Epson Tyocom, product code and marking will still remain as previously identified prior to the merger. Due to the on going strategy of gradual unification of part numbers, please review product code and marking as they will change during the course of the coming months. We apologize for the inconvenience, but we will eventually have a unified part numbering system for Epson Toyocom which will be user friendly.

Contents

1. Overview	1
2. Block Diagram	1
3. Terminal description	2
3.1. Terminal connections	2
3.2. Pin Functions	2
4. Absolute Maximum Ratings	3
5. Recommended Operating Conditions	3
6. Frequency Characteristics	3
7. Electrical Characteristics	3
7.1. DC characteristics (1)	3
7.2. DC characteristics (2)	4
7.3. AC Characteristics	4
8. Use Methods	5
8.1. Overview of Functions	5
8.2. Description of Registers	6
8.3. Fixed-cycle Timer Interrupt Function	13
8.4. Time Update Interrupt Function	16
8.5. Alarm Interrupt Function	18
8.6. Reading/Writing Data via the I ² C Bus Interface	21
8.7. Backup and Recovery	25
8.8. Connection with Typical Microcontroller	25
9. External Dimensions / Marking Layout	26
9.1. External dimensions	26
9.2. Marking layout	26
10. Reference Data	27
11. Application notes	28

For Automotive Applications, I²C-Bus Interface Real-time Clock Module

RA – 8581 SA

- It is suitable for the car accessories
- Features built-in 32.768-kHz crystal oscillator, frequency adjusted
- Supports I²C-Bus's high speed mode (400 kHz)
- Alarm interrupt function for day, date, hour, and minute settings
- Fixed-cycle timer interrupt function
- Time update interrupt function (Seconds, minutes)
- 32.768-kHz output with OE function (FOE and FOUT pins)
- Auto correction of leap years (from 2000 to 2099)
- Wide interface voltage range: 1.8 V to 5.5 V
- Wide time-keeping voltage range: 1.6 V to 5.5 V
- Low current consumption: 0.45 μA /3 V (Typ.)

The I²C-Bus is a trademark of NXP Semiconductors

1. Overview

This module is an I²C bus interface-compliant real-time clock which includes a 32.768-kHz crystal oscillator. In addition to providing a calendar (year, month, date, day, hour, minute, second) function and a clock counter function, this module provides an abundance of other functions including an alarm function, fixed-cycle timer function, time update interrupt function, and 32.768-kHz output function. The devices in this module are fabricated via a C-MOS process for low current consumption, which enables long-term battery back-up.

2. Block Diagram

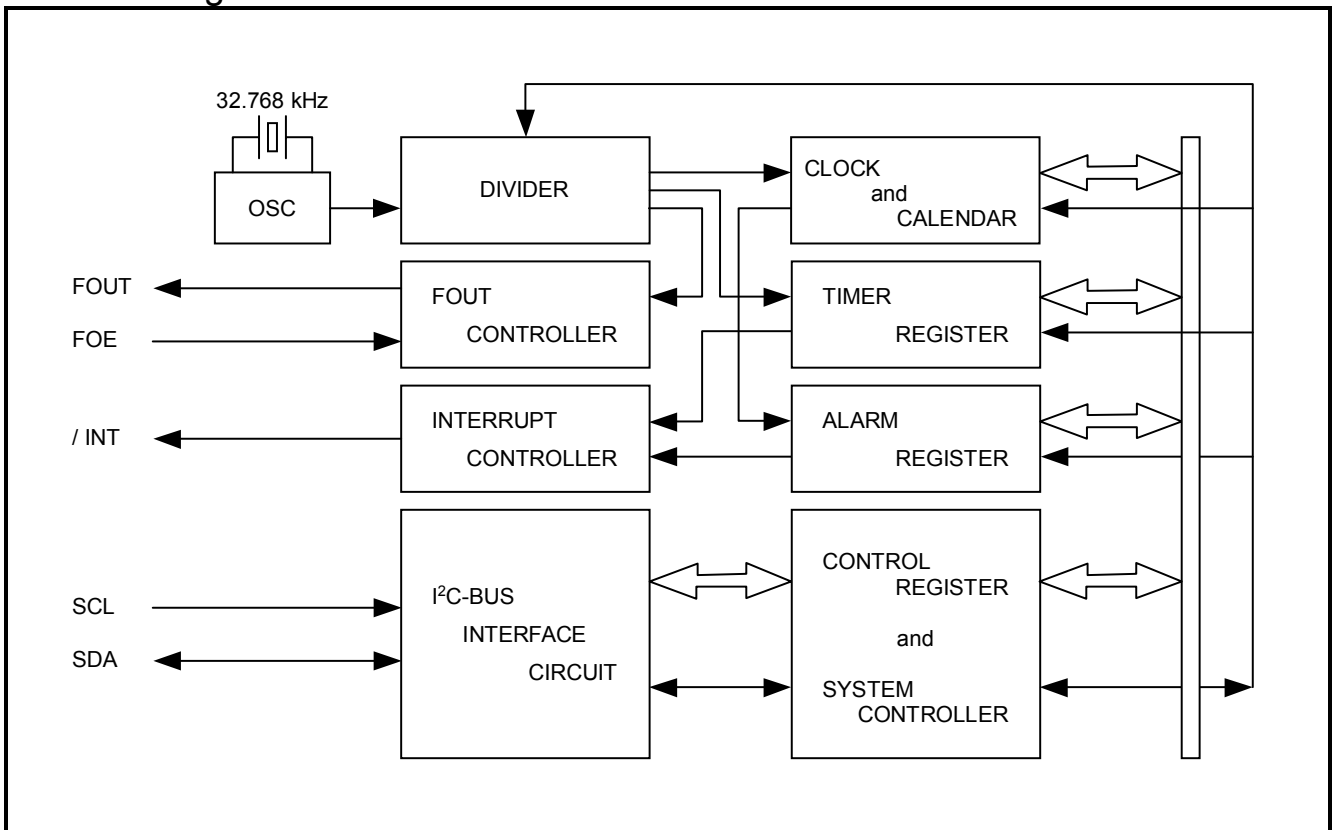

3. Terminal description

3.1. Terminal connections

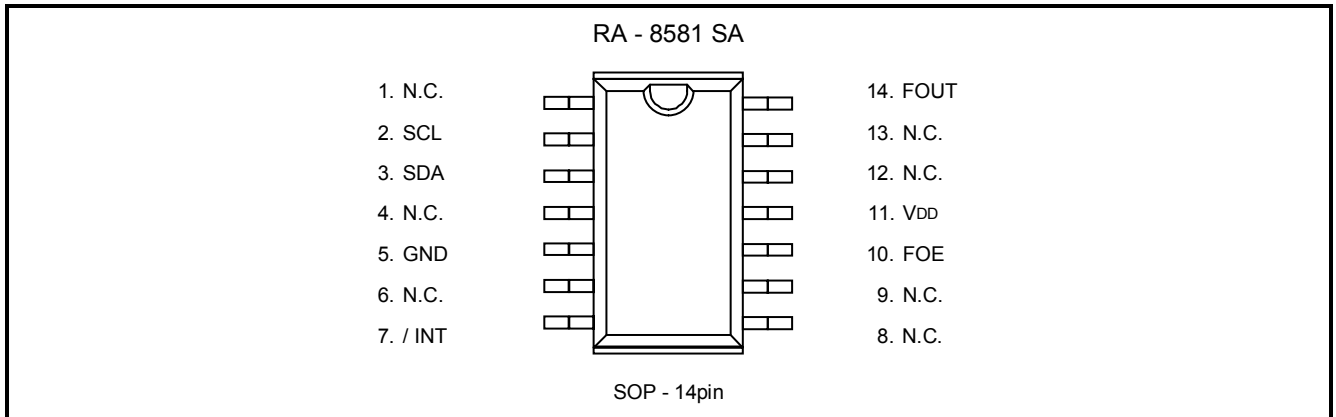

3.2. Pin Functions

Signal name	I/O	Function
SCL	I	This is the serial clock input pin for I ² C Bus communications.
SDA	I/O	This pin's signal is used for input and output of address, data, and ACK bits, synchronized with the serial clock used for I ² C communications. Since the SDA pin is an N-ch open drain pin during output, be sure to connect a suitable pull-up resistance relative to the signal line capacity.
FOUT	O	This is the C-MOS output pin with output control provided via the FOE pin. When FOE = "H" (high level), this pin outputs a 32.768-kHz signal. When output is stopped, the FOUT pin = "L" (low level).
FOE	I	This is an input pin used to control the output mode of the FOUT pin. When this pin's level is high, the FOUT pin is in output mode. When it is low, output via the FOUT pin is stopped.
/INT	O	This pins is used to output alarm signals, timer signals, time update signals, and other signals. This pin is an open drain pin.
VDD	-	This pin is connected to a positive power supply.
GND	-	This pin is connected to a ground.
N.C.	-	This pin is not connected to the internal IC. Leave N.C. pins open or connect them to GND or VDD.

Note: Be sure to connect a bypass capacitor rated at least 0.1 μF between VDD and GND.

4. Absolute Maximum Ratings

GND = 0 V

Item	Symbol	Condition	Rating	Unit
Supply voltage	V _{DD}	Between V _{DD} and GND	-0.3 to +7.0	V
Input voltage (1)	V _{IN1}	FOE pin	GND-0.3 to V _{DD} +0.3	V
Input voltage (2)	V _{IN2}	SCL and SDA pins	GND-0.3 to +8.0	V
Output voltage (1)	V _{OUT1}	FOUT pin	GND-0.3 to V _{DD} +0.3	V
Output voltage (2)	V _{OUT2}	SDA and /INT pins	GND-0.3 to +8.0	V
Storage temperature	T _{STG}	When stored separately, without packaging	-55 to +125	°C

5. Recommended Operating Conditions

GND = 0 V V

Item	Symbol	Condition	Min.	Typ.	Max.	Unit
Operating supply voltage	V _{DD}	-	1.8	3.0	5.5	V
Clock supply voltage	V _{CLK}	-	1.6	3.0	5.5	V
Operating temperature	T _{OPR}	No condensation	-40	+25	+85	°C

6. Frequency Characteristics

GND = 0 V

Item	Symbol	Condition	Rating	Unit
Frequency precision	$\Delta f / f$	T _a = +25 °C, V _{DD} = 3.0 V	5 ± 23 (*1)	X10 ⁻⁶
Frequency/voltage characteristics	f / V	T _a = +25 °C, V _{DD} = 2.0 V to 5.0 V	± 2 Max.	X10 ⁻⁶ /V
Frequency/temperature characteristics	T _{OP}	T _a = -20 °C to +70 °C, V _{DD} = 3.0 V; +25 °C reference	+10 / -120	X10 ⁻⁶
Oscillation start time	t _{STA}	T _a = -40 °C to +85 °C, V _{DD} = 3.0 V	3 Max.	s
Aging	f _a	T _a = +25 °C, V _{DD} = 3.0 V, first year	± 5 Max.	X10 ⁻⁶ /year

(*1) Precision gap per month: 1 minutes (excluding offset value)

7. Electrical Characteristics

7.1. DC characteristics (1) *Unless otherwise specified, GND = 0 V, V_{DD} = 1.8 V to 5.5V, T_a = -40°C to +85°C

Item	Symbol	Condition	Min.	Typ.	Max.	Unit
Current consumption (1)	I _{DD1}	f _{SCL} = 0 Hz /INT = V _{DD} , FOE = GND FOUT; output OFF	V _{DD} = 5 V	0.65	1.2	μA
Current consumption (2)	I _{DD2}	(low level)	V _{DD} = 3 V	0.45	0.8	
Current consumption (3)	I _{DD3}	f _{SCL} = 0 Hz /INT, FOE = V _{DD} FOUT;	V _{DD} = 5 V	3.0	7.5	μA
Current consumption (4)	I _{DD4}	32.768 kHz output ON, CL = 0 pF	V _{DD} = 3 V	1.7	4.5	
Current consumption (5)	I _{DD5}	f _{SCL} = 0 Hz /INT, FOE = V _{DD} FOUT ;	V _{DD} = 5 V	8.0	20.0	μA
Current consumption (6)	I _{DD6}	32.768 kHz output ON, CL = 30 pF	V _{DD} = 3 V	5.0	12.0	
High-level input voltage	V _{IH1}	FOE pin	0.7 x V _{DD}		V _{DD} + 0.3	V
	V _{IH2}	SCL and SDA pins	0.7 x V _{DD}		6.0	V
Low-level input voltage	V _{IL}	Input pin	GND - 0.3		0.3 x V _{DD}	V
High-level output voltage	V _{OH1}	FOUT pin	V _{DD} =5 V, I _{OH} =-1 mA	4.5	5.0	V
	V _{OH2}		V _{DD} =3 V, I _{OH} =-1 mA	2.2	3.0	
	V _{OH3}		V _{DD} =3 V, I _{OH} =-100 μA	2.9	3.0	
Low-level output voltage	V _{OL1}	FOUT pin	V _{DD} =5 V, I _{OL} =1 mA	GND	GND+0.5	V
	V _{OL2}		V _{DD} =3 V, I _{OL} =1 mA	GND	GND+0.8	
	V _{OL3}		V _{DD} =3 V, I _{OL} =100 μA	GND	GND+0.1	
	V _{OL4}	/INT pin	V _{DD} =5 V, I _{OL} =1 mA	GND	GND+0.25	V
	V _{OL5}		V _{DD} =3 V, I _{OL} =1 mA	GND	GND+0.4	
	V _{OL6}	SDA pin	V _{DD} > 2 V, I _{OL} =3 mA	GND		GND+0.4

7.2. DC characteristics (2) *Unless otherwise specified, GND =0V, VDD = 1.8 V to 5.5 V, Ta = -40°C to+85°C

Item	Symbol	Condition	Min.	Typ.	Max.	Unit
Input leakage current	I _{LK}	Input pin, V _{IN} = V _{DD} or GND	-0.5		0.5	μA
Output leakage current	I _{oZ}	/INT, SDA, FOUT pins, V _{OUT} = V _{DD} or GND	-0.5		0.5	μA

7.3. AC Characteristics * Unless otherwise specified, GND=0V, VDD=1.8V to 5.5V, Ta=-40°C to+85°C

Item	Symbol	Condition	Min.	Typ.	Max.	Unit
SCL clock frequency	f _{SCL}				400	kHz
Start condition setup time	t _{SU;STA}		0.6			μs
Start condition hold time	t _{HD;STA}		0.6			μs
Data setup time	t _{SU;DAT}		100			ns
Data hold time	t _{HD;DAT}		0			ns
Stop condition setup time	t _{SU;STO}		0.6			μs
Bus idle time between start condition and stop condition	t _{BUF}		1.3			μs
Time when SCL = "L"	t _{LOW}		1.3			μs
Time when SCL = "H"	t _{HIGH}		0.6			μs
Rise time for SCL and SDA	t _r				0.3	μs
Fall time for SCL and SDA	t _f				0.3	s
Allowable spike time on bus	t _S P				50	ns
FOUT duty	t _W / t	V _{DD} = 2.4 V ~ 5.5 V 50% of V _{DD} level	45	50	55	%

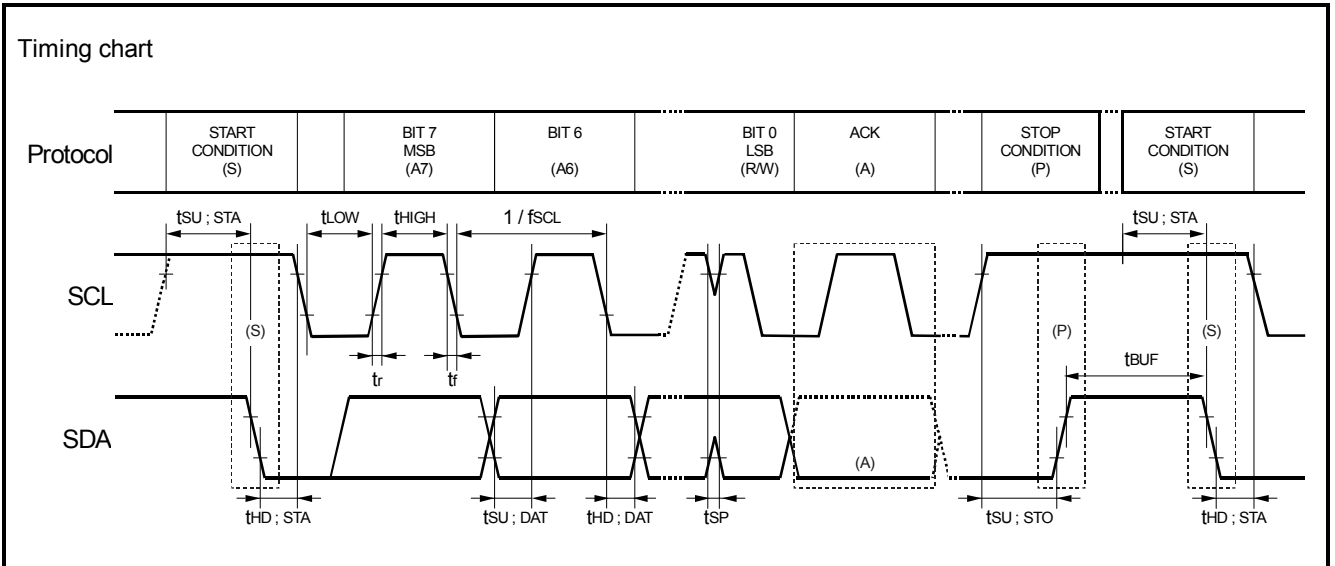

Caution: When accessing this device, all communication from transmitting the start condition to transmitting the stop condition after access should be completed within 0.95 seconds. If such communication requires 0.95 seconds or longer, the I²C bus interface is reset by the internal bus timeout function.

Data writing : It's necessary to input the data of 8-bit units. During inputting the data of 8-bit units, a state of suspension occurs, the data are not written appropriately.

8. Use Methods

8.1. Overview of Functions

1) Clock functions

This function is used to set and read out month, day, hour, date, minute, second, and year (last two digits) data. Any (two-digit) year that is a multiple of 4 is treated as a leap year and calculated automatically as such until the year 2099.

* For details, see "8.2. Description of Registers".

2) Fixed-cycle interrupt generation function

The fixed-cycle timer interrupt generation function generates an interrupt event periodically at any fixed cycle set between 244.14 μ s and 4095 minutes.

When an interrupt event is generated, the /INT pin goes to low level ("L") and "1" is set to the TF bit to report that an event has occurred. (However, when a fixed-cycle timer interrupt event has been generated, low-level output from the /INT pin occurs only when the value of the control register's TIE bit is "1". Up to 7.8 ms after the interrupt occurs, the /INT status is automatically cleared (/INT status changes from low level to Hi-Z).

* For details, see "8.3. Fixed-cycle Interrupt Function".

3) Time update interrupt function

The time update interrupt function generates interrupt events at one-second or one-minute intervals, according to the timing of the internal clock.

When an interrupt event occurs, the UF bit value becomes "1" and the /INT pin goes to low level to indicate that an event has occurred. (However, when a fixed-cycle timer interrupt event has been generated, low-level output from the /INT pin occurs only when the value of the control register's UIE bit is "1". This /INT status is automatically cleared (/INT status changes from low level to Hi-Z) 7.8 ms (a fixed value) after the interrupt occurs.

* For details, see "8.4. Time Update Interrupt Function".

4) Alarm interrupt function

The alarm interrupt generation function generates interrupt events for alarm settings such as date, day, hour, and minute settings.

When an interrupt event occurs, the AF bit value is set to "1" and the /INT pin goes to low level to indicate that an event has occurred.

* For details, see "8.5. Alarm Interrupt Function".

5) 32.768-kHz clock output

The 32.768-kHz clock (with precision equal to that of the built-in crystal oscillator) can be output via the FOUT pin. The FOUT pin is a CMOS output pin which can be set for clock output when the FOE pin is at high level and for low-level output when the FOE pin is at low level.

6) Interface with CPU

Data is read and written via the I²C bus interface using two signal lines: SCL (clock) and SDA (data).

Since neither SCL nor SDA includes a protective diode on the V_{DD} side, a data interface between hosts with differing supply voltages can still be implemented by adding pull-up resistors to the circuit board.

The SCL's maximum clock frequency is 400 kHz (when V_{DD} > 1.8 V), which supports the I²C bus's high-speed mode.

* For further description of data read/write operations, see "8.6 Reading/Writing Data via the I²C Bus Interface".

8.2. Description of Registers

8.2.1. Register table

Address	Function	bit 7	bit 6	bit 5	bit 4	bit 3	bit 2	bit 1	bit 0	Remark
0	SEC	○	40	20	10	8	4	2	1	*3
1	MIN	○	40	20	10	8	4	2	1	*3
2	HOUR	○	○	20	10	8	4	2	1	*3
3	WEEK	○	6	5	4	3	2	1	0	*3
4	DAY	○	○	20	10	8	4	2	1	*3
5	MONTH	○	○	○	10	8	4	2	1	*3
6	YEAR	80	40	20	10	8	4	2	1	-
7	RAM	•	•	•	•	•	•	•	•	*4
8	MIN Alarm	AE	40	20	10	8	4	2	1	-
9	HOUR Alarm	AE	•	20	10	8	4	2	1	*4
A	WEEK Alarm	AE	6	5	4	3	2	1	0	*4
	DAY Alarm		•	20	10	8	4	2	1	
B	Timer Counter 0	128	64	32	16	8	4	2	1	-
C	Timer Counter 1	•	•	•	•	2048	1024	512	256	*4
D	Extension Register	TEST	WADA	USEL	TE	○	○	TSEL1	TSEL0	*1, *3, *5
E	Flag Register	○	○	UF	TF	AF	○	VLF	○	*1, *2, *3
F	Control Register	○	○	UIE	TIE	AIE	○	STOP	RESET	*3

Note When after the initial power-up or when the result of read out the VLF bit is "1", initialize all registers, before using the module.

Be sure to avoid entering incorrect date and time data, as clock operations are not guaranteed when the data or time data is incorrect.

- *1) During the initial power-up, the TEST bit is reset to "0" and the VLF bit is set to "1".
* At this point, all other register values are undefined, so be sure to perform a reset before using the module.
- *2) Only a "0" can be written to the UF, TF, AF, or VLF bit.
- *3) Any bit marked with "○" should be used with a value of "0" after initialization.
- *4) Any bit marked with "•" is a RAM bit that can be used to read or write any data.
- *5) The TEST bit is used by the manufacturer for testing. Be sure to set "0" for this bit when writing.

8.2.2. Control register (Reg F)

Address	Function	bit 7	bit 6	bit 5	bit 4	bit 3	bit 2	bit 1	bit 0
F	Control Register (Default)	○ (0)	○ (0)	UIE (-)	TIE (-)	AIE (-)	○ (0)	STOP (-)	RESET (-)

*1) The default value is the value that is read (or is set internally) after powering up from 0 V.

*2) "o" indicates write-protected bits. A zero is always read from these bits.

*3) "-" indicates no default value has been defined.

- This register is used to control interrupt event output from the /INT pin and the stop/start status of clock and calendar operations.

1) UIE (Update Interrupt Enable) bit

When a time update interrupt event is generated (when the UF bit value changes from "0" to "1"), this bit's value specifies if an interrupt signal is generated (/INT status changes from Hi-Z to low) or is not generated (/INT status remains Hi-Z).

When a "1" is written to this bit, an interrupt signal is generated (/INT status changes from Hi-Z to low) when an interrupt event is generated.

When a "0" is written to this bit, no interrupt signal is generated when an interrupt event occurs.

UIE	Data	Function
Write/Read	0	When a time update interrupt event occurs, an interrupt signal is not generated or is canceled (/INT status changes from low to Hi-Z).
	1	When a time update interrupt event occurs, an interrupt signal is generated (/INT status changes from Hi-Z to low). * When a time update interrupt event occurs, low-level output from the /INT pin occurs only when the value of the control register's UIE bit is "1". This /INT status is automatically cleared (/INT status changes from low to Hi-Z) 7.8 ms after the interrupt occurs.

* For details, see "8.4. Time Update Interrupt Function".

2) TIE (Timer Interrupt Enable) bit

When a fixed-cycle timer interrupt event occurs (when the TF bit value changes from "0" to "1"), this bit's value specifies if an interrupt signal is generated (/INT status changes from Hi-Z to low) or is not generated (/INT status remains Hi-Z).

When a "1" is written to this bit, an interrupt signal is generated (/INT status changes from Hi-Z to low) when an interrupt event is generated.

When a "0" is written to this bit, no interrupt signal is generated when an interrupt event occurs.

TIE	Data	Function
Write/Read	0	When a fixed-cycle timer interrupt event occurs, an interrupt signal is not generated or is canceled (/INT status changes from low to Hi-Z).
	1	When a fixed-cycle timer interrupt event occurs, an interrupt signal is generated (/INT status changes from Hi-Z to low). * When a fixed-cycle timer interrupt event has been generated low-level output from the /INT pin occurs only when the value of the control register's TIE bit is "1". Up to 7.8 ms after the interrupt occurs, the /INT status is automatically cleared (/INT status changes from low to Hi-Z).

* For details, see "8.3. Fixed-cycle Timer Interrupt Function".

3) AIE (Alarm Interrupt Enable) bit

When an alarm timer interrupt event occurs (when the AF bit value changes from "0" to "1"), this bit's value specifies if an interrupt signal is generated (/INT status changes from Hi-Z to low) or is not generated (/INT status remains Hi-Z).

When a "1" is written to this bit, an interrupt signal is generated (/INT status changes from Hi-Z to low) when an interrupt event is generated.

When a "0" is written to this bit, no interrupt signal is generated when an interrupt event occurs.

AIE	Data	Function
Write/Read	0	When an alarm interrupt event occurs, an interrupt signal is not generated or is canceled (/INT status changes from low to Hi-Z).
	1	When an alarm interrupt event occurs, an interrupt signal is generated (/INT status changes from Hi-Z to low). * When an alarm interrupt event has been generated low-level output from the /INT pin occurs only when the value of the control register's AIE bit is "1". This setting is retained until the AF bit value is cleared to zero. (No automatic cancellation)

* For details, see "8.5. Alarm Interrupt Function".

[Caution]

(1) The /INT pin is a shared interrupt output pin for three types of interrupts. It outputs the OR'ed result of these interrupt outputs.

When an interrupt has occurred (when the /INT pin is at low level), the UF, TF, read AF flags to determine which flag has a value of "1" (this indicates which type of interrupt event has occurred).

(2) To keep the /INT pin from changing to low level, write "0" to the UIE, TIE, and AIE bits. To check whether an event has occurred without outputting any interrupts via the /INT pin, use software to monitor the value of the UF, TF, and AF interrupt flags.

4) STOP bit

This bit is used to stop functions related to the RTC's internal counter operations.

Writing a "1" to this bit stops the counter operations.

Writing a "0" to this bit cancels stop status (restarts operations).

* For optimum performance, do not use this bit for functions other than the clock and calendar functions.

STOP	Data	Description
Write/Read	0	<p>[Normal operation mode]</p> <p>This bit is used to cancel stop status for (i.e., restart) the clock and calendar function. Also, when "1" is written to the STOP bit, it cancels stop status for the fixed-cycle timer function.</p> <p>* When the RESET bit value is "1" operation will not be restarted. To restart operation, a "0" must be written to both the STOP bit and the RESET bit.</p>
	1	<p>[Operation stop mode]</p> <p>Stops updating of year, month, date, day, hour, minute, and second values and partially stops the fixed-cycle timer function.</p> <p>(Stop 1) Stops updating of year, month, date, day, hour, minute, and second values</p> <ul style="list-style-type: none"> - This stops all clock and calendar update operations. <p>Once this occurs, no more time update interrupt events or alarm interrupt events occur.</p> <p>(Stop 2) Partially stops the fixed-cycle timer function</p> <ul style="list-style-type: none"> - If the fixed-cycle timer's source clock settings include an update setting of 64 Hz, 1 Hz, or "Minute", the fixed-cycle timer function does not operate. <p>* However, this function does operate when the fixed-cycle timer's source clock setting is 4096 Hz.</p> <p>When this bit value is "1", internal divider stops from 2048Hz to 1 Hz .</p>

5) RESET bit

Like the STOP function described above, this function stops functions related to counter operations. It also resets the RTC module's internal counter value when the value is less than one second.

Writing a "1" to this bit stops the counter operation and resets the RTC module's internal counter value when the value is less than one second.

Writing a "0" to this bit cancels stop status for (restarts) these operations. If a STOP condition or repeated START condition is received while the 0.95-second bus timeout function is operating, stop status is automatically canceled (the RESET bit value is changed from "1" to "0").

* For optimum performance, do not use this bit for functions other than the clock and calendar functions.

RESET	Data	Description
Write/Read	0	<p>[Normal operation mode]</p> <p>This bit is used to cancel stop status for (i.e., restart) the clock and calendar function. Also, when "1" is written to the RESET bit, it cancels stop status for the fixed-cycle timer function.</p> <p>* Since operation is not restarted when the STOP bit value is "1", to restart operation, a "0" must be written to both the STOP bit and the RESET bit.</p>
	1	<p>[Operation stop mode]</p> <p>Stops updating of year, month, date, day, hour, minute, and second values and partially stops the fixed-cycle timer function.</p> <p>(Stop 1) Stops updating of year, month, date, day, hour, minute, and second values</p> <ul style="list-style-type: none"> - This stops all clock and calendar update operations. <p>Once this occurs, no more time update interrupt events or alarm interrupt events occur.</p> <p>(Stop 2) Partially stops the fixed-cycle timer function</p> <ul style="list-style-type: none"> - If the fixed-cycle timer's source clock settings include an update setting of 64 Hz, 1 Hz, or "Minute", the fixed-cycle timer function does not operate. <p>* However, this function does operate when the fixed-cycle timer's source clock setting is 4096 Hz.</p> <p>(Note) When this bit value is "1", the internal divider keeps the reset state, from 2048Hz to 1 Hz .</p>

8.2.3. Flag register (Reg-E)

Address	Function	bit 7	bit 6	bit 5	bit 4	bit 3	bit 2	bit 1	bit 0
E	Flag register (Default)	○ (0)	○ (0)	UF (-)	TF (-)	AF (-)	○ (0)	VLF (1)	○ (0)

*1) The default value is the value that is read (or is set internally) after powering up from 0 V.

*2) "o" indicates write-protected bits. A zero is always read from these bits.

*3) "-" indicates a default value is undefined.

- This register is used to detect the occurrence of various interrupt events and reliability problems in internal data.

1) UF (Update Flag) bit

If set to "0" beforehand, this flag bit's value changes from "0" to "1" when a time update interrupt event has occurred. Once this flag bit's value is "1", its value is retained until a "0" is written to it.

* For details, see "8.4. Time Update Interrupt Function".

2) TF (Timer Flag) bit

If set to "0" beforehand, this flag bit's value changes from "0" to "1" when a fixed-cycle timer interrupt event has occurred. Once this flag bit's value is "1", its value is retained until a "0" is written to it.

* For details, see "8.3. Fixed-cycle Timer Interrupt Function".

3) AF (Alarm Flag) bit

If set to "0" beforehand, this flag bit's value changes from "0" to "1" when an alarm interrupt event has occurred. Once this flag bit's value is "1", its value is retained until a "0" is written to it.

* For details, see "8.5. Alarm Interrupt Function".

4) VLF (Voltage Low Flag) bit

This flag bit indicates the retained status of clock operations or internal data. Its value changes from "0" to "1" when data loss occurs, such as due to a supply voltage drop. Once this flag bit's value is "1", its value is retained until a "0" is written to it.

This bit's value is "1" after powering up from 0 V.

VLF	Data	Description
Write	0	The VLF bit is cleared to zero to prepare for the next status detection.
	1	This bit is invalid after a "1" has been written to it.
Read	0	Data loss is not detected.
	1	Data loss is detected. All registers must be initialized. (This setting is retained until a "zero" is written to this bit.)

8.2.4. Extension register (Reg-D)

Address	Function	bit 7	bit 6	bit 5	bit 4	bit 3	bit 2	bit 1	bit 0
D	Extension Register (Default)	TEST (0)	WADA (-)	USEL (-)	TE (-)	○ (0)	○ (0)	TSEL1 (-)	TSEL0 (-)

*1) The default value is the value that is read (or is set internally) after powering up from 0 V.

*2) "o" indicates write-protected bits. A zero is always read from these bits.

*3) "-" indicates a default value is undefined.

- This register is used to specify the target for the alarm function or time update interrupt function and to select or set operations such as fixed-cycle timer operations.

1) TEST bit

This is the manufacturer's test bit. Its value should always be "0".

Be careful to avoid writing a "1" to this bit when writing to other bits.

* If a "1" is inadvertently written to this TEST bit, there is a safety function where by this bit will be automatically cleared to zero when a STOP condition or Repeated START condition is received or when the 0.95-second bus timeout function operates.

TEST	Data	Description
Write/Read	0	Normal operation mode *Default
	1	Setting prohibited (manufacturer's test bit)

2) WADA (Week Alarm/Day Alarm) bit

This bit is used to specify either WEEK or DAY as the target of the alarm interrupt function.

Writing a "1" to this bit specifies DAY as the comparison object for the alarm interrupt function.

Writing a "0" to this bit specifies WEEK as the comparison object for the alarm interrupt function.

* For details, see "8.5. Alarm Interrupt Function".

3) USEL (Update Interrupt Select) bit

This bit is used to specify either "second update" or "minute update" as the update generation timing of the time update interrupt function.

Writing a "1" to this bit specifies the internal clock's "minute update" (once per minute) operation as the timing by which time update interrupts are generated.

Writing a "0" to this bit specifies the internal clock's "second update" (once per second) operation as the timing by which time update interrupts are generated.

* For details, see "8.4. Time Update Interrupt Function".

4) TE (Timer Enable) bit

This bit controls the start/stop setting for the fixed-cycle timer interrupt function.

Writing a "1" to this bit specifies starting of the fixed-cycle timer interrupt function (a countdown starts from a preset value).

Writing a "0" to this bit specifies stopping of the fixed-cycle timer interrupt function.

* For details, see "8.3. Fixed-cycle Timer Interrupt Function".

5) TSEL0,1 (Timer Select 0, 1) bits

The combination of these two bits is used to set the countdown period (source clock) for the fixed-cycle timer interrupt function (four settings can be made).

TSEL0,1	TSEL1 (bit 1)	TSEL0 (bit 0)	Source clock
Write/Read	0	0	4096 Hz /Once per 244.14 μs
	0	1	64 Hz / Once per 15.625 ms
	1	0	"Second" update /Once per second
	1	1	"Minute" update /Once per minute

* For details, see "8.3. Fixed-cycle Timer Interrupt Function".

8.2.5. RAM register (Reg - 7)

Address	Function	bit 7	bit 6	bit 5	bit 4	bit 3	bit 2	bit 1	bit 0
7	RAM	•	•	•	•	•	•	•	•

- This RAM register is read/write accessible for any data in the range from 00 h to FF h.

8.2.6. Clock counter (Reg - 0 ~ 2)

Address	Function	bit 7	bit 6	bit 5	bit 4	bit 3	bit 2	bit 1	bit 0
0	SEC	○	40	20	10	8	4	2	1
1	MIN	○	40	20	10	8	4	2	1
2	HOUR	○	○	20	10	8	4	2	1

*) "o" indicates write-protected bits. A zero is always read from these bits.

- The clock counter counts seconds, minutes, and hours.

- The data format is BCD format. For example, when the "seconds" register value is "0101 1001" it indicates 59 seconds.

* Note with caution that writing non-existent time data may interfere with normal operation of the clock counter.

1) Second counter

Address	Function	bit 7	bit 6	bit 5	bit 4	bit 3	bit 2	bit 1	bit 0
0	SEC	○	40	20	10	8	4	2	1

- This second counter counts from "00" to "01," "02," and up to 59 seconds, after which it starts again from 00 seconds.

2) Minute counter

Address	Function	bit 7	bit 6	bit 5	bit 4	bit 3	bit 2	bit 1	bit 0
1	MIN	○	40	20	10	8	4	2	1

- This minute counter counts from "00" to "01," "02," and up to 59 minutes, after which it starts again from 00 minutes.

3) Hour counter

Address	Function	bit 7	bit 6	bit 5	bit 4	bit 3	bit 2	bit 1	bit 0
2	HOUR	○	○	20	10	8	4	2	1

- This hour counter counts from "00" hours to "01," "02," and up to 23 hours, after which it starts again from 00 hours.

8.2.7. Day counter (Reg - 3)

Address	Function	bit 7	bit 6	bit 5	bit 4	bit 3	bit 2	bit 1	bit 0
3	WEEK	○	6	5	4	3	2	1	0

*) "o" indicates write-protected bits. A zero is always read from these bits.

- The day (of the week) is indicated by 7 bits, bit 0 to bit 6.

The day data values are counted as: Day 01h → Day 02h → Day 04h → Day 08h → Day 10h → Day 20h → Day 40h → Day 01h → Day 02h, etc.

- The correspondence between days and count values is shown below.

WEEK	bit 7	bit 6	bit 5	bit 4	bit 3	bit 2	bit 1	bit 0	Day	Data [h]
Write/Read	0	0	0	0	0	0	0	1	Sunday	01 h
	0	0	0	0	0	0	1	0	Monday	02 h
	0	0	0	0	0	1	0	0	Tuesday	04 h
	0	0	0	0	1	0	0	0	Wednesday	08 h
	0	0	1	0	0	0	0	0	Thursday	10 h
	0	0	1	0	0	0	0	0	Friday	20 h
	0	1	0	0	0	0	0	0	Saturday	40 h
Write prohibit	* Do not set "1" to more than one day at the same time. Also, note with caution that any setting other than the seven shown above should not be made as it may interfere with normal operation.								-	-

8.2.8. Calendar counter (Reg 4 to 6)

Address	Function	bit 7	bit 6	bit 5	bit 4	bit 3	bit 2	bit 1	bit 0
4	DAY	○	○	20	10	8	4	2	1
5	MONTH	○	○	○	10	8	4	2	1
6	YEAR	80	40	20	10	8	4	2	1

*) "o" indicates write-protected bits. A zero is always read from these bits.

- The auto calendar function updates all dates, months, and years from January 1, 2001 to December 31, 2099.

- The data format is BCD format. For example, a date register value of "0011 0001" indicates the 31st.

* Note with caution that writing non-existent date data may interfere with normal operation of the calendar counter.

1) Date counter

Address	Function	bit 7	bit 6	bit 5	bit 4	bit 3	bit 2	bit 1	bit 0
4	DAY	○	○	20	10	8	4	2	1

- The updating of dates by the date counter varies according to the month setting.

* A leap year is set whenever the year value is a multiple of four (such as 04, 08, 12, 88, 92, or 96). In February of a leap year, the counter counts dates from "01," "02," "03," to "28," "29," "01," etc.

DAY	Month	Date update pattern
Write/Read	1, 3, 5, 7, 8, 10, or 12	01, 02, 03 ~ 30, 31, 01 ~
	4, 6, 9, or 11	01, 02, 03 ~ 30, 01, 02 ~
	February in normal year	01, 02, 03 ~ 28, 01, 02 ~
	February in leap year	01, 02, 03 ~ 28, 29, 01 ~

2) Month counter

Address	Function	bit 7	bit 6	bit 5	bit 4	bit 3	bit 2	bit 1	bit 0
5	MONTH	○	○	○	10	8	4	2	1

- The month counter counts from 01 (January), 02 (February), and up to 12 (December), then starts again at 01 (January).

3) Year counter

Address	Function	bit 7	bit 6	bit 5	bit 4	bit 3	bit 2	bit 1	bit 0
6	Years	Y80	Y40	Y20	Y10	Y8	Y4	Y2	Y1

- The year counter counts from 00, 01, 02 and up to 99, then starts again at 00.

- Any year that is a multiple of four (04, 08, 12, 88, 92, 96, etc.) is handled as a leap year.

8.2.9. Alarm registers (Reg – 8 ~ A)

Address	Function	bit 7	bit 6	bit 5	bit 4	bit 3	bit 2	bit 1	bit 0
8	MIN Alarm	AE	40	20	10	8	4	2	1
9	HOUR Alarm	AE	•	20	10	8	4	2	1
A	WEEK Alarm	AE	6	5	4	3	2	1	0
	DAY Alarm		•	20	10	8	4	2	1

- The alarm interrupt function is used, along with the AEI, AF, and WADA bits, to set alarms for specified date, day, hour, and minute values.

- When the settings in the above alarm registers and the WADA bit match the current time, the /INT pin goes to low level and "1" is set to the AF bit to report that an alarm interrupt event has occurred.

* For details, see "8.5. Alarm Interrupt Function".

8.2.10. Fixed-cycle timer control registers (Reg - B ~ C)

Address	Function	bit 7	bit 6	bit 5	bit 4	bit 3	bit 2	bit 1	bit 0
B	Timer Counter 0	128	64	32	16	8	4	2	1
C	Timer Counter 1	•	•	•	•	2048	1024	512	256

- These registers are used to set the preset countdown value for the fixed-cycle timer interrupt function.

The TE, TF, TIE, and TSEL0/1 bits are also used to set the fixed-cycle timer interrupt function.

- When the value in the above fixed-cycle timer control register changes from 001h to 000h, the /INT pin goes to low level and "1" is set to the TF bit to report that a fixed-cycle timer interrupt event has occurred.

* For details, see "8.3. Fixed-cycle Timer Interrupt Function".

8.3. Fixed-cycle Timer Interrupt Function

The fixed-cycle timer interrupt generation function generates an interrupt event periodically at any fixed cycle set between 244.14 μ s and 4095 minutes.

When an interrupt event is generated, the /INT pin goes to low level and "1" is set to the TF bit to report that an event has occurred. (However, when a fixed-cycle timer interrupt event has been generated low-level output from the /INT pin occurs only when the value of the control register's TIE bit is "1". Up to 7.8 ms after the interrupt occurs, the /INT status is automatically cleared (/INT status changes from low-level to Hi-Z).

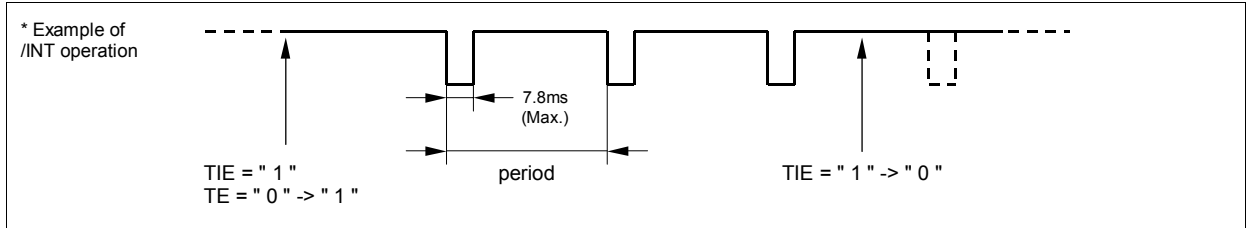

8.3.1. Diagram of fixed-cycle timer interrupt function

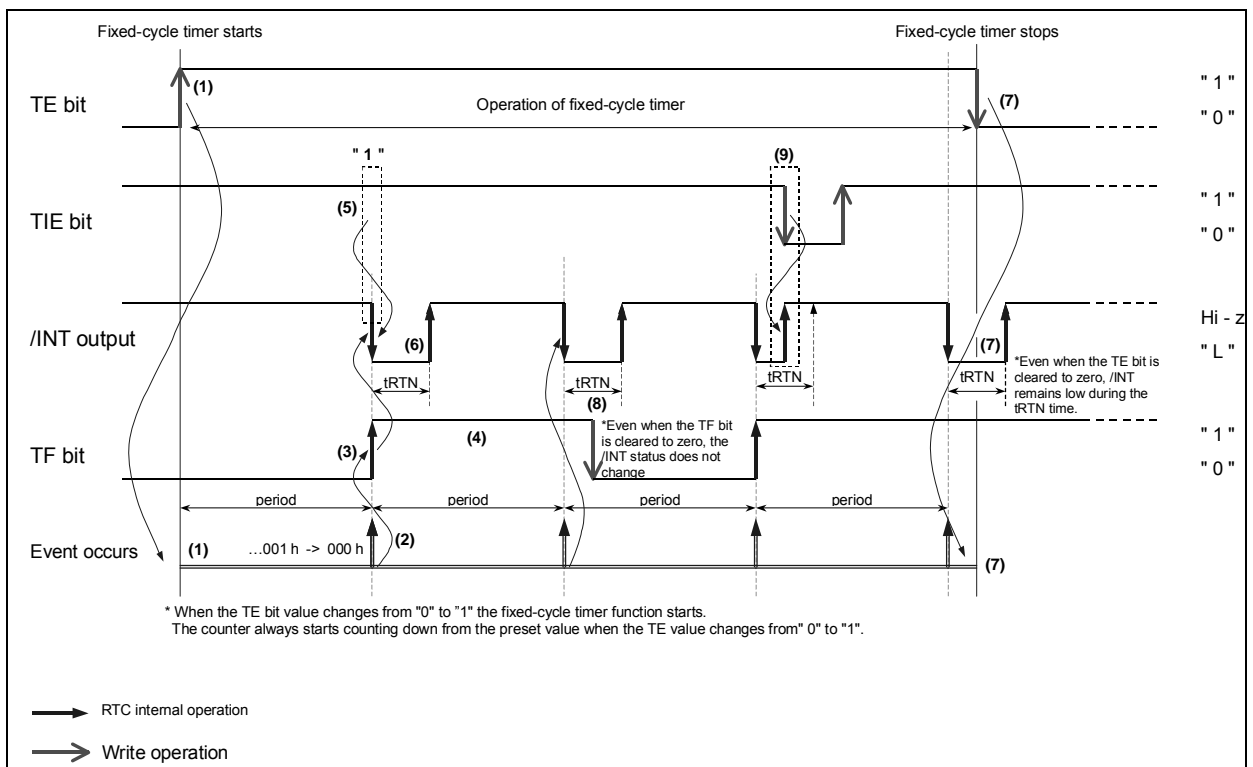

- (1) When a "1" is written to the TE bit, the fixed-cycle timer countdown starts from the preset value.
- (2) A fixed-cycle timer interrupt event starts a countdown based on the countdown period (source clock). When the count value changes from 001h to 000h, an interrupt event occurs.
* After the interrupt event that occurs when the count value changes from 001h to 000h, the counter automatically reloads the preset value and again starts to count down. (Repeated operation)
- (3) When a fixed-cycle timer interrupt event occurs, "1" is written to the TF bit.
- (4) When the TF bit = "1" its value is retained until it is cleared to zero.
- (5) If the TIE bit = "1" when a fixed-cycle timer interrupt occurs, /INT pin output goes low.
* If the TIE bit = "0" when a fixed-cycle timer interrupt occurs, /INT pin output remains Hi-Z.
- (6) Output from the /INT pin remains low during the tRTN period following each event, after which it is automatically cleared to Hi-Z status.
* /INT is again set low when the next interrupt event occurs.
- (7) When a "0" is written to the TE bit, the fixed-cycle timer function is stopped and the /INT pin is set to Hi-Z status.
* When /INT = low, the fixed-cycle timer function is stopped. The tRTN period is the maximum amount of time before the /INT pin status changes from low to Hi-Z.
- (8) As long as /INT = low, the /INT pin status does not change when the TF bit value changes from "1" to "0".
- (9) When /INT = low, the /INT pin status changes from low to Hi-Z as soon as the TIE bit value changes from "1" to "0".

8.3.2. Related registers for function of time update interrupts.

Address	Function	bit 7	bit 6	bit 5	bit 4	bit 3	bit 2	bit 1	bit 0
B	Timer Counter 0	128	64	32	16	8	4	2	1
C	Timer Counter 1	•	•	•	•	2048	1024	512	256
D	Extension Register	TEST	WADA	USEL	TE	○	○	TSEL1	TSEL0
E	Flag Register	○	○	UF	TF	AF	○	VLF	○
F	Control Register	○	○	UIE	TIE	AIE	○	STOP	RESET

*1) "o" indicates write-protected bits. A zero is always read from these bits.

*2) Bits marked with "•" are RAM bits that can contain any value and are read/write-accessible.

* Before entering settings for operations, we recommend writing a "0" to the TE and TIE bits to prevent hardware interrupts from occurring inadvertently while entering settings.

* When the STOP bit or RESET bit value is "1" the time update interrupt function operates only partially. (Operation continues if the source clock setting is 4096 Hz. Otherwise, operation is stopped.)

* When the fixed-cycle timer interrupt function is not being used, the fixed-cycle timer control register (Reg – B to C) can be used as a RAM register. In such cases, stop the fixed-cycle timer function by writing "0" to the TE and TIE bits.

1) TSEL0,1 bits (Timer Select 0, 1)

The combination of these two bits is used to set the countdown period (source clock) for the fixed-cycle timer interrupt function (four settings can be made).

TSEL0,1	TSEL1 (bit 1)	TSEL0 (bit 0)	Source clock	Auto reset time tRTN	Effects of STOP and RESET bits
Write/Read	0	0	4096 Hz /Once per 244.14 μs	122 μs	-
	0	1	64 Hz / Once per 15.625 ms	7.8125 ms	* Does not operate when the STOP bit or RESET bit value is "1".
	1	0	1 Hz /Once per second	7.8125 ms	
	1	1	"Minute" update /Once per minute	7.8125 ms	

*1) The /INT pin's auto reset time (tRTN) varies as shown above according to the source clock setting.

*2) When the source clock has been set to "second update" or "minute update", the timing of both countdown and interrupts is coordinated with the clock update timing.

2) Fixed-cycle Timer Control register (Reg - B ~ C)

This register is used to set the default (preset) value for the counter. Any count value from 1 (001 h) to 4095 (FFFh) can be set. The counter counts down based on the source clock's period, and when the count value changes from 001h to 000h, the TF bit value becomes "1".

The countdown that starts when the TE bit value changes from "0" to "1" always begins from the preset value. Be sure to write "0" to the TE bit before writing the preset value. If a value is written while TE = "1" the first subsequent event will not be generated correctly.

Address C								Address B							
Timer Counter 1								Timer Counter 0							
bit 7	bit 6	bit 5	bit 4	bit 3	bit 2	bit 1	bit 0	bit 7	bit 6	bit 5	bit 4	bit 3	bit 2	bit 1	bit 0
•	•	•	•	2048	1024	512	256	128	64	32	16	8	4	2	1

3) TE (Timer Enable) bit

This bit controls the start/stop setting for the fixed-cycle timer interrupt function.

TE	Data	Description
Write/Read	0	Stops fixed-cycle timer interrupt function.
	1	Starts fixed-cycle timer interrupt function. * The countdown that starts when the TE bit value changes from "0" to "1" always begins from the preset value.

4) TF (Timer Flag) bit

If set to "0" beforehand, this flag bit's value changes from "0" to "1" when a fixed-cycle timer interrupt event has occurred. Once this flag bit's value is "1", its value is retained until a "0" is written to it.

TF	Data	Description
Write	0	The TF bit is cleared to zero to prepare for the next status detection * Clearing this bit to zero does not enable the /INT low output status to be cleared (to Hi-Z).
	1	This bit is invalid after a "1" has been written to it.
Read	0	Fixed-cycle timer interrupt events are not detected.
	1	Fixed-cycle timer interrupt events are detected. (Result is retained until this bit is cleared to zero.)

5) TIE (Timer Interrupt Enable) bit

When a fixed-cycle timer interrupt event occurs (when the TF bit value changes from "0" to "1"), this bit's value specifies whether an interrupt signal is generated (/INT status changes from Hi-Z to low) or is not generated (/INT status remains Hi-Z).

TIE	Data	Description
Write/Read	0	1) When a fixed-cycle timer interrupt event occurs, an interrupt signal is not generated or is canceled (/INT status remains Hi-Z). 2) When a fixed-cycle timer interrupt event occurs, the interrupt signal is canceled (/INT status changes from low to Hi-Z). * Even when the TIE bit value is "0" another interrupt event may change the /INT status to low (or may hold /INT = "L").
	1	When a fixed-cycle timer interrupt event occurs, an interrupt signal is generated (/INT status changes from Hi-Z to low). * When a fixed-cycle timer interrupt event has been generated low-level output from the /INT pin occurs only when the value of the control register's TIE bit is "1". Up to 7.8 ms after the interrupt occurs, the /INT status is automatically cleared (/INT status changes from low to Hi-Z).

8.3.3. Fixed-cycle timer interrupt interval (example)

Timer Counter setting	Source clock			
	4096 Hz TSEL1,0 = 0,0	64 Hz TSEL1,0 = 0,1	1 Hz TSEL1,0 = 1,0	"Minute" update TSEL1,0 = 1,1
0	-	-	-	-
1	244.14 μs	15.625 ms	1 s	1 min
2	488.28 μs	31.25 ms	2 s	2 min
⋮	⋮	⋮	⋮	⋮
41	10.010 ms	640.63 ms	41 s	41 min
205	50.049 ms	3.203 s	205 s	205 min
410	100.10 ms	6.406 s	410 s	410 min
2048	500.00 ms	32.000 s	2048 s	2048 min
⋮	⋮	⋮	⋮	⋮
4095	0.9998 s	63.984 s	4095 s	4095 min

- Time error in fixed-cycle timer

A time error in the fixed-cycle timer will produce a positive or negative time period error in the selected source clock. The fixed-cycle timer's time is within the following range relative to the time setting.

(Fixed-cycle timer's time setting (*) - source clock period) to (timer's time setting)
 *) The timer's time setting = source clock period x timer counter's division value.

* The time actually set to the timer is adjusted by adding the time described above to the communication time for the serial data transfer clock used for the setting.

8.3.4. Fixed-cycle timer start timing

Counting down of the fixed-cycle timer value starts at the rising edge of the SCL signal that occurs when the TE value is changed from "0" to "1" (after bit 0 is transferred).

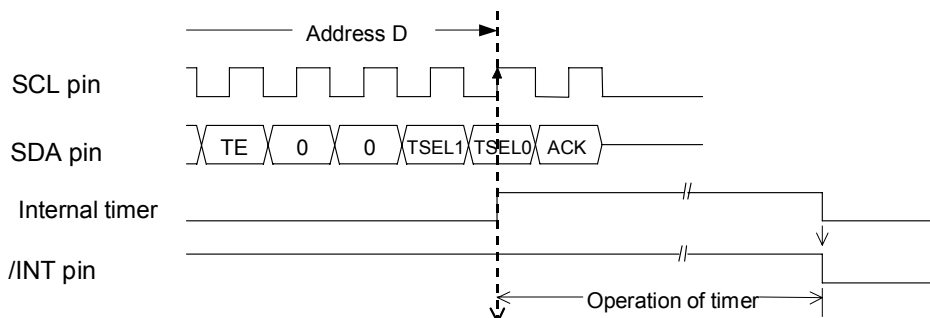

8.4. Time Update Interrupt Function

The time update interrupt function generates interrupt events at one-second or one-minute intervals, according to the timing of the internal clock.

When an interrupt event occurs, the UF bit value becomes "1" and the /INT pin goes to low level to indicate that an event has occurred. (However, when a fixed-cycle timer interrupt event has been generated, low-level output from the /INT pin occurs only when the value of the control register's UIE bit is "1". This /INT status is automatically cleared (/INT status changes from low level to Hi-Z) 7.8 ms (fixed value) after the interrupt occurs.

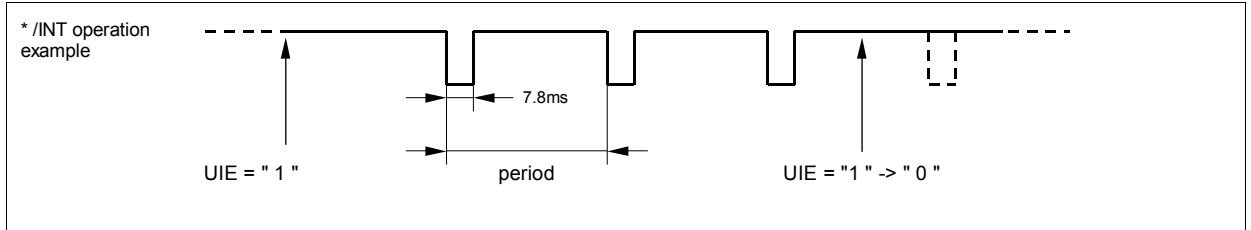

8.4.1. Time update interrupt function diagram

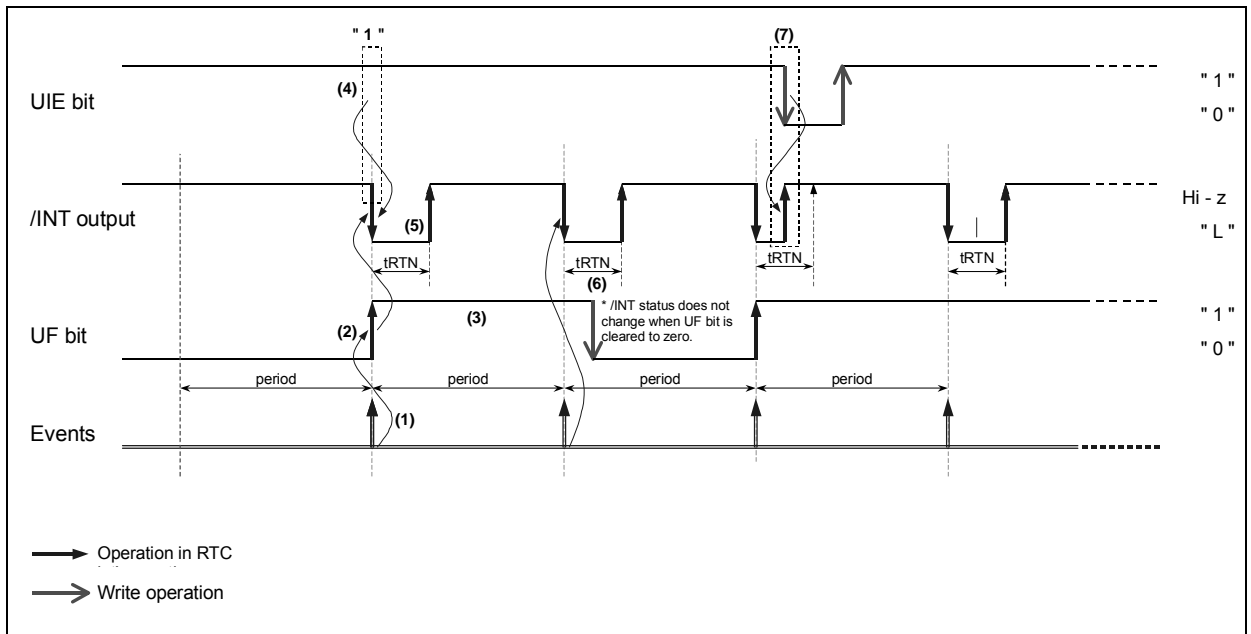

- (1) A time update interrupt event occurs when the internal clock's value matches either the second update time or the minute update time. The USEL bit's specification determines whether it is the second update time or the minute update time that must be matched.
- (2) When a time update interrupt event occurs, the UF bit value becomes "1".
- (3) When the UF bit value is "1" its value is retained until it is cleared to zero.
- (4) When a time update interrupt occurs, /INT pin output is low if UIE = "1".
* If UIE = "0" when a timer update interrupt occurs, the /INT pin status remains Hi-Z.
- (5) Each time an event occurs, /INT pin output is low only up to the tRTN time (which is fixed as 7.1825 ms for time update interrupts) after which it is automatically cleared to Hi-Z.
* /INT pin output goes low again when the next interrupt event occurs.
- (6) As long as /INT = low, the /INT pin status does not change, even if the UF bit value changes from "1" to "0".
- (7) When /INT = low, the /INT pin status changes from low to Hi-Z as soon as the UIE bit value changes from "1" to "0".

8.4.2. Related registers for time update interrupt functions.

Address	Function	bit 7	bit 6	bit 5	bit 4	bit 3	bit 2	bit 1	bit 0
D	Extension Register	TEST	WADA	USEL	TE	○	○	TSEL1	TSEL0
E	Flag Register	○	○	UF	TF	AF	○	VLf	○
F	Control Register	○	○	UIE	TIE	AIE	○	STOP	RESET

*) "○" indicates write-protected bits. A zero is always read from these bits.

- * Before entering settings for operations, we recommend writing a "0" to the UIE bit to prevent hardware interrupts from occurring inadvertently while entering settings.
- * When the STOP bit or RESET bit value is "1" time update interrupt events do not occur.
- * Although the time update interrupt function cannot be fully stopped, if "0" is written to the UIE bit, the time update interrupt function can be prevented from changing the /INT pin status to low.

1) USEL (Update Interrupt Select) bit

This bit is used to select "second" update or "minute" update as the timing for generation of time update interrupt events.

USEL	Data	Description
Write/Read	0	Selects "second update" (once per second) as the timing for generation of interrupt events
	1	Selects "minute update" (once per minute) as the timing for generation of interrupt events

2) UF (Update Flag) bit

Once it has been set to "0", this flag bit value changes from "0" to "1" when a time update interrupt event occurs. When this flag bit = "1" its value is retained until a "0" is written to it.

UF	Data	Description
Write	0	The UF bit is cleared to zero to prepare for the next status detection * Clearing this bit to zero does not enable the /INT low output status to be cleared (to Hi-Z).
	1	This bit is invalid after a "1" has been written to it.
Read	0	Time update interrupt events are not detected.
	1	Time update interrupt events are detected. (The result is retained until this bit is cleared to zero.)

3) UIE (Update Interrupt Enable) bit

When a time update interrupt event occurs (UF bit value changes from "0" to "1"), this bit selects whether to generate an interrupt signal (/INT status changes from Hi-Z to low) or to not generate it (/INT status remains Hi-Z).

UIE	Data	Description
Write/Read	0	1) Does not generate an interrupt signal when a time update interrupt event occurs (/INT remains Hi-Z) 2) Cancels interrupt signal triggered by time update interrupt event (/INT changes from low to Hi-Z). * Even when the UIE bit value is "0" another interrupt event may change the /INT status to low (or may hold /INT = "L").
	1	When a time update interrupt event occurs, an interrupt signal is generated (/INT status changes from Hi-Z to low). * When a time update interrupt event occurs, low-level output from the /INT pin occurs only when the UIE bit value is "1". Up to 7.8 ms after the interrupt occurs, the /INT status is automatically cleared (/INT status changes from low to Hi-Z).

8.5. Alarm Interrupt Function

The alarm interrupt generation function generates interrupt events for alarm settings such as date, day, hour, and minute settings.
 When an interrupt event occurs, the AF bit value is set to "1" and the /INT pin goes to low level to indicate that an event has occurred.

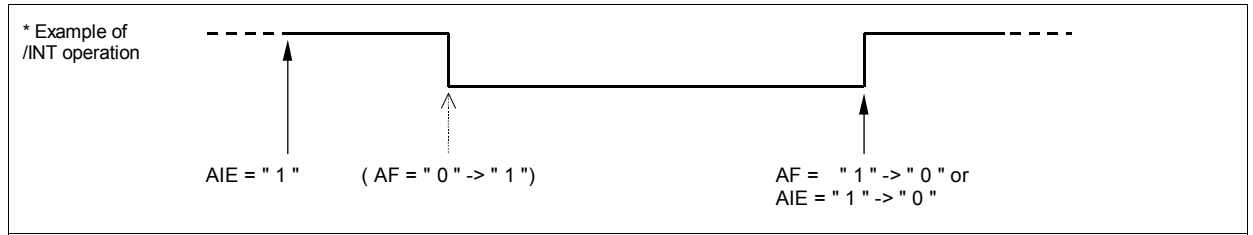

8.4.1. Diagram of alarm interrupt function

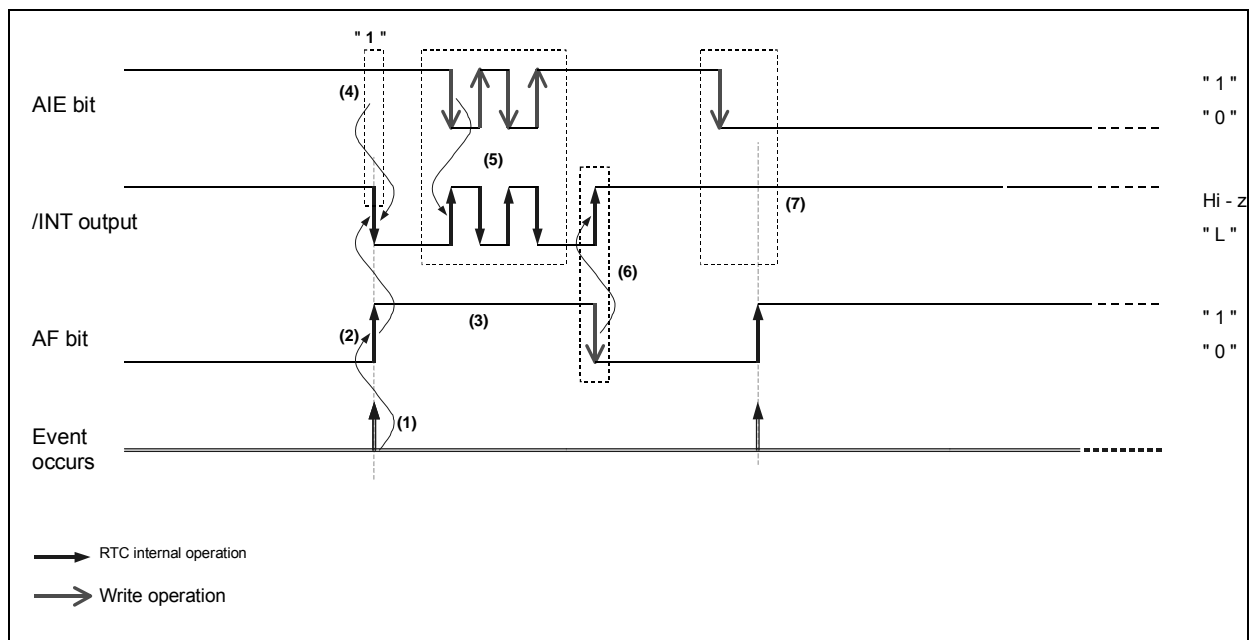

- (1) The hour, minute, date or day when an alarm interrupt event is to occur is set in advance along with the WADA bit, and when the setting matches the current time an interrupt event occurs.
 (Note) Even if the current date/time is used as the setting, the alarm will not occur until the counter counts up to the current date/time (i.e., an alarm will occur next time, not immediately).
- (2) When a time update interrupt event occurs, the AF bit values becomes "1".
- (3) When the AF bit = "1", its value is retained until it is cleared to zero.
- (4) If AIE = "1" when an alarm interrupt occurs, the /INT pin output goes low.
 * When an alarm interrupt event occurs, /INT pin output goes low, and this status is then held until it is cleared via the AF bit or AIE bit.
- (5) If the AIE value is changed from "1" to "0" while /INT is low, the /INT status immediately changes from low to Hi-Z. After the alarm interrupt occurs and before the AF bit value is cleared to zero, the /INT status can be controlled via the AIE bit.
- (6) If the AF bit value is changed from "1" to "0" while /INT is low, the /INT status immediately changes from low to Hi-Z.
- (7) If the AIE bit value is "0" when an alarm interrupt occurs, the /INT pin status remains Hi-Z.

8.5.2. Related registers

Address	Function	bit 7	bit 6	bit 5	bit 4	bit 3	bit 2	bit 1	bit 0
1	MIN	○	40	20	10	8	4	2	1
2	HOUR	○	○	20	10	8	4	2	1
3	WEEK	○	6	5	4	3	2	1	0
4	DAY	○	○	20	10	8	4	2	1
8	MIN Alarm	AE	40	20	10	8	4	2	1
9	HOUR Alarm	AE	●	20	10	8	4	2	1
A	WEEK Alarm	AE	6	5	4	3	2	1	0
	DAY Alarm		●	20	10	8	4	2	1
D	Extension Register	TEST	WADA	USEL	TE	○	○	TSEL1	TSEL0
E	Flag Register	○	○	UF	TF	AF	○	VLF	○
F	Control Register	○	○	UIE	TIE	AIE	○	STOP	RESET

*1) "o" indicates write-protected bits. A zero is always read from these bits.

*2) Bits marked with "•" are RAM bits that can contain any value and are read/write-accessible.

* Before entering settings for operations, we recommend writing a "0" to the AIE bit to prevent hardware interrupts from occurring inadvertently while entering settings.

* When the STOP bit or RESET bit value is "1" alarm interrupt events do not occur.

* When the alarm interrupt function is not being used, the Alarm registers (Reg - 8 to A) can be used as a RAM register. In such cases, be sure to write "0" to the AIE bit.

* When the AIE bit value is "1" and the Alarm registers (Reg - 8 to A) is being used as a RAM register, /INT may be changed to low level unintentionally.

1) WADA (Week Alarm /Day Alarm) bit

The alarm interrupt function uses either "Day" or "Week" as its target. The WADA bit is used to specify either WEEK or DAY as the target for alarm interrupt events.

WADA	Data	Description
Write/Read	0	Sets WEEK as target of alarm function (DAY setting is ignored)
	1	Sets DAY as target of alarm function (WEEK setting is ignored)

2) Alarm registers (Reg - 8 to A)

Address	Function	bit 7	bit 6	bit 5	bit 4	bit 3	bit 2	bit 1	bit 0
8	MIN Alarm	AE	40	20	10	8	4	2	1
9	HOUR Alarm	AE	●	20	10	8	4	2	1
A	WEEK Alarm	AE	6	5	4	3	2	1	0
	DAY Alarm		●	20	10	8	4	2	1

The hour, minute, date or day when an alarm interrupt event will occur is set using this register and the WADA bit.

In the WEEK alarm /Day alarm register (Reg - A), the setting selected via the WADA bit determines whether WEEK alarm data or DAY alarm data will be set. If WEEK has been selected via the WADA bit, multiple days can be set (such as Monday, Wednesday, Friday, Saturday).

When the settings made in the alarm registers and the WADA bit match the current time, the AF bit value is changed to "1". At that time, if the AIE bit value has already been set to "1", the /INT pin goes low.

*1) The register that "1" was set to "AE" bit, doesn't compare alarm.

(Example) Write 80h (AE = "1") to the WEEK Alarm /DAY Alarm register (Reg - A):

Only the hour and minute settings are used as alarm comparison targets. The week and date settings are not used as alarm comparison targets.

As a result, alarm occurs if only an hour and minute accords with alarm data.

*2) If all three AE bit values are "1" the week/date settings are ignored and an alarm interrupt event will occur once per minute.

3) AF (Alarm Flag) bit

When this flag bit value is already set to "0", occurrence of an alarm interrupt event changes it to "1". When this flag bit value is "1", its value is retained until a "0" is written to it.

AF	Data	Description
Write	0	The AF bit is cleared to zero to prepare for the next status detection * Clearing this bit to zero enables /INT low output to be canceled (/INT remains Hi-Z) when an alarm interrupt event has occurred.
	1	This bit is invalid after a "1" has been written to it.
Read	0	Alarm interrupt events are not detected.
	1	Alarm interrupt events are detected. (Result is retained until this bit is cleared to zero.)

4) AIE (Alarm Interrupt Enable) bit

When an alarm interrupt event occurs (when the AF bit value changes from "0" to "1"), this bit's value specifies whether an interrupt signal is generated (/INT status changes from Hi-Z to low) or is not generated (/INT status remains Hi-Z).

AIE	Data	Description
Write/Read	0	1) When an alarm interrupt event occurs, an interrupt signal is not generated or is canceled (/INT status remains Hi-Z). 2) When an alarm interrupt event occurs, the interrupt signal is canceled (/INT status changes from low to Hi-Z). * Even when the AIE bit value is "0" another interrupt event may change the /INT status to low (or may hold /INT = "L").
	1	When an alarm interrupt event occurs, an interrupt signal is generated (/INT status changes from Hi-Z to low). * When an alarm interrupt event occurs, low-level output from the /INT pin occurs only when the AIE bit value is "1". This value is retained (not automatically cleared) until the AF bit is cleared to zero.

8.5.2. Examples of alarm settings

1) Example of alarm settings when "Day" has been specified (and WADA bit = "0")

Day is specified WADA bit = "0"	Reg - A								Reg - 9	Reg - 8
	bit 7 AE	bit 6 S	bit 5 F	bit 4 T	bit 3 W	bit 2 T	bit 1 M	bit 0 S	HOUR Alarm	MIN Alarm
Monday through Friday, at 7:00 AM * Minute value is ignored	0	0	1	1	1	1	1	0	07 h	80 h ~ FF h
Every Saturday and Sunday, for 30 minutes each hour * Hour value is ignored	0	1	0	0	0	0	0	1	80 h ~ FF h	30 h
Every day, at 6:59 AM	1	x	x	x	x	x	x	x	18 h	59 h

x: Don't care

2) Example of alarm settings when "Day" has been specified (and WADA bit = "1")

Day is specified WADA bit = "1"	Reg - A								Reg - 9	Reg - 8
	bit 7 AE	bit 6 •	bit 5 20	bit 4 10	bit 3 08	bit 2 04	bit 1 02	bit 0 01	HOUR Alarm	MIN Alarm
First of each month, at 7:00 AM * Minute value is ignored	0	0	0	0	0	0	0	1	07 h	80 h ~ FF h
15 th of each month, for 30 minutes each hour * Hour value is ignored	0	0	0	1	0	1	0	1	80 h ~ FF h	30 h
Every day, at 6:59 PM	1	x	x	x	x	x	x	x	18 h	59 h

x: Don't care

8.6. Reading/Writing Data via the I²C Bus Interface

8.6.1. Overview of I²C-BUS

The I²C bus supports bi-directional communications via two signal lines: the SDA (data) line and SCL (clock) line. A combination of these two signals is used to transmit and receive communication start/stop signals, data transfer signals, acknowledge signals, and so on.

Both the SCL and SDA signals are held at high level whenever communications are not being performed. The starting and stopping of communications is controlled at the rising edge or falling edge of SDA while SCL is at high level.

During data transfers, data changes that occur on the SDA line are performed while the SCL line is at low level, and on the receiving side the data is output while the SCL line is at high level.

The I²C bus device does not include a chip select pin such as is found in ordinary logic devices. Instead of using a chip select pin, slave addresses are allocated to each device and the receiving device responds to communications only when its slave address matches the slave address in the received data. In either case, the data is transferred via the SCL line at a rate of one bit per clock pulse.

8.6.2. System configuration

All ports connected to the I²C bus must be either open drain or open collector ports in order to enable AND connections to multiple devices.

SCL and SDA are both connected to the V_{DD} line via a pull-up resistance. Consequently, SCL and SDA are both held at high level when the bus is released (when communication is not being performed).

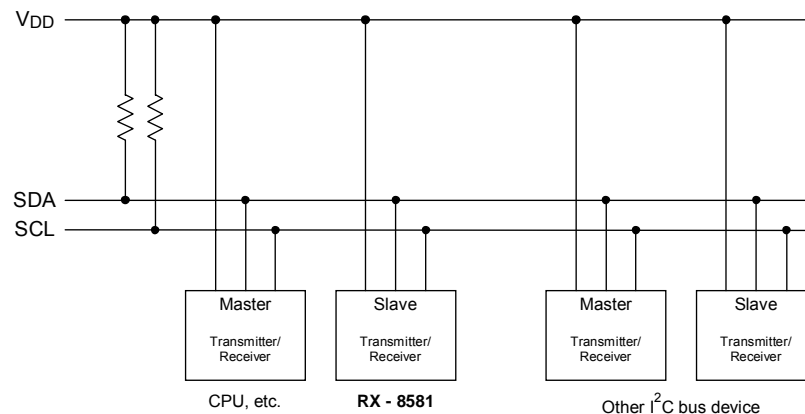

Any device that controls the data transmission and data reception is defined as a "Master".

and any device that is controlled by a master device is defined as a "Slave".

The device transmitting data is defined as a "Transmitter" and the device receiving data is defined as a receiver"

In the case of this RTC module, controllers such as a CPU are defined as master devices and the RTC module is defined as a slave device. When a device is used for both transmitting and receiving data, it is defined as either a transmitter or receiver depending on these conditions.

8.6.3. Starting and stopping I²C bus communications

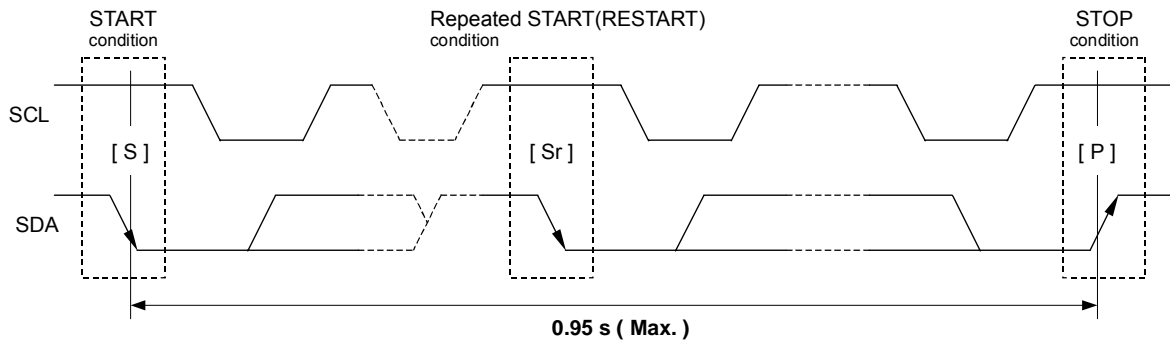

1) START condition, repeated START condition, and STOP condition

- (1) START condition
 - The SDA level changes from high to low while SCL is at high level.
- (2) STOP condition
 - This condition regulates how communications on the I²C-BUS are terminated. The SDA level changes from low to high while SCL is at high level.
- (3) Repeated START condition (RESTART condition)
 - In some cases, the START condition occurs between a previous START condition and the next STOP condition, in which case the second START condition is distinguished as a RESTART condition. Since the required status is the same as for the START condition, the SDA level changes from high to low while SCL is at high level.

2) Caution points

- *1) The master device always controls the START, RESTART, and STOP conditions for communications.
- *2) The master device does not impose any restrictions on the timing by which STOP conditions affect transmissions, so communications can be forcibly stopped at any time while in progress. (However, this is only when this RTC module is in receiver mode (data reception mode = SDA released).)
- *3) When communicating with this RTC module, the series of operations from transmitting the START condition to transmitting the STOP condition should occur within 0.95 seconds. (A RESTART condition may be sent between a START condition and STOP condition, but even in such cases the series of operations from transmitting the START condition to transmitting the STOP condition should still occur within 0.95 seconds.)

If this series of operations requires 0.95 seconds or longer, the I²C bus interface will be automatically cleared and set to standby mode by this RTC module's bus timeout function. Note with caution that both write and read operations are invalid for communications that occur during or after this auto clearing operation. (When the read operation is invalid, all data that is read has a value of "1"). Restarting of communications begins with transfer of the START condition again

- *4) When communicating with this RTC module, wait at least 1.3 μs (see the tBUF rule) between transferring a STOP condition (to stop communications) and transferring the next START condition (to start the next round of communications).

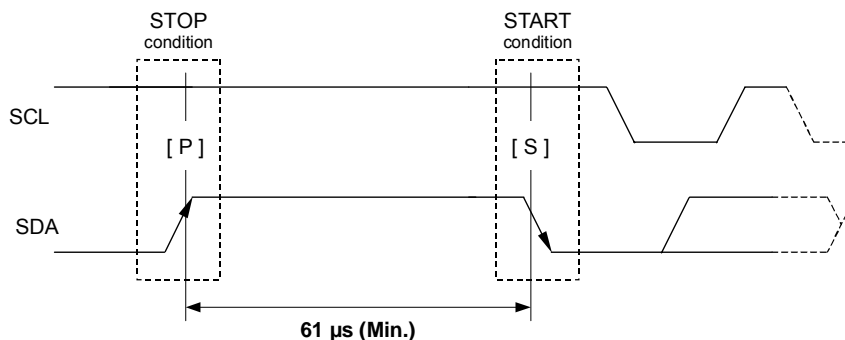

8.6.4. Data transfers and acknowledge responses during I²C-BUS communications

1) Data transfers

Data transfers are performed in 8-bit (1 byte) units once the START condition has occurred. There is no limit on the amount (bytes) of data that are transferred between the START condition and STOP condition. (However, the transfer time must be no longer than 0.95 seconds.)

The address auto increment function operates during both write and read operations. After address Fh, incrementation goes to address 0h.

Updating of data on the transmitter (transmitting side)'s SDA line is performed while the SCL line is at low level. The receiver (receiving side) receives data while the SCL line is at high level.

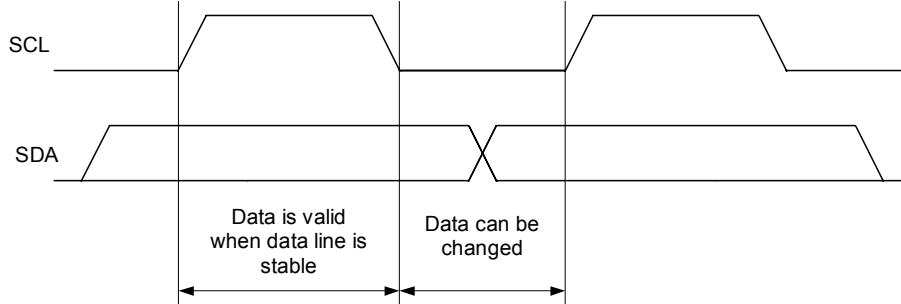

* Note with caution that if the SDA data is changed while the SCL line is at high level, it will be treated as a START, RESTART, or STOP condition.

2) Data acknowledge response (ACK signal)

When transferring data, the receiver generates a confirmation response (ACK signal, low active) each time an 8-bit data segment is received. If there is no ACK signal from the receiver, it indicates that normal communication has not been established. (This does not include instances where the master device intentionally does not generate an ACK signal.)

Immediately after the falling edge of the clock pulse corresponding to the 8th bit of data on the SCL line, the transmitter releases the SDA line and the receiver sets the SDA line to low (= acknowledge) level.

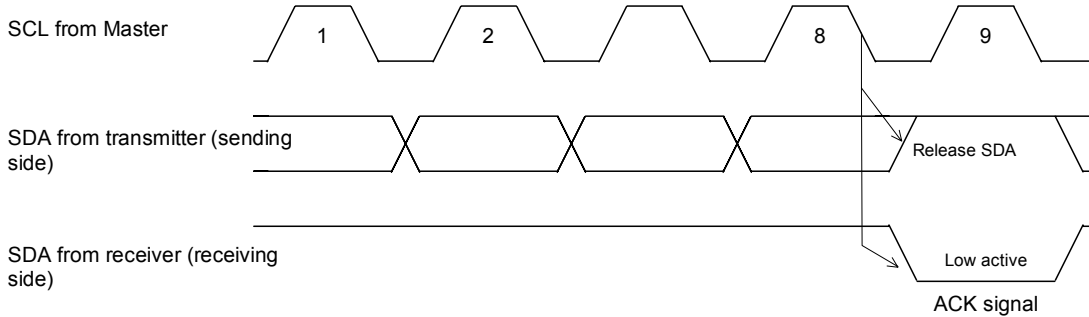

After transmitting the ACK signal, if the Master remains the receiver for transfer of the next byte, the SDA is released at the falling edge of the clock corresponding to the 9th bit of data on the SCL line. Data transfer resumes when the Master becomes the transmitter.

When the Master is the receiver, if the Master does not send an ACK signal in response to the last byte sent from the slave, that indicates to the transmitter that data transfer has ended. At that point, the transmitter continues to release the SDA and awaits a STOP condition from the Master.

8.6.5. Slave address

The I²C bus device does not include a chip select pin such as is found in ordinary logic devices. Instead of using a chip select pin, slave addresses are allocated to each device.

All communications begin with transmitting the [START condition] + [slave address (+ R/W specification)]. The receiving device responds to this communication only when the specified slave address it has received matches its own slave address.

Slave addresses have a fixed length of 7 bits. This RTC's slave address is [1010 001*]. An R/W bit ("*" above) is added to each 7-bit slave address during 8-bit transfers.

	Transfer data	Slave address							R/W bit
		bit 7	bit 6	bit 5	bit 4	bit 3	bit 2	bit 1	bit 0
Read	A3 h	1	0	1	0	0	0	1	1 (= Read)
Write	A2 h								0 (= Write)

8.6.6. I²C bus protocol

In the following sequence descriptions, it is assumed that the CPU is the master and the RA-8581 is the slave.

a. Address specification write sequence

Since the RA-8581 includes an address auto increment function, once the initial address has been specified, the RA-8581 increments (by one byte) the receive address each time data is transferred.

- (1) CPU transfers start condition [S].
- (2) CPU transmits the RA-8581's slave address with the R/W bit set to write mode.
- (3) Check for ACK signal from RA-8581.
- (4) CPU transmits write address to RA-8581.
- (5) Check for ACK signal from RA-8581.
- (6) CPU transfers write data to the address specified at (4) above.
- (7) Check for ACK signal from RA-8581.
- (8) Repeat (6) and (7) if necessary. Addresses are automatically incremented.
- (9) CPU transfers stop condition [P].

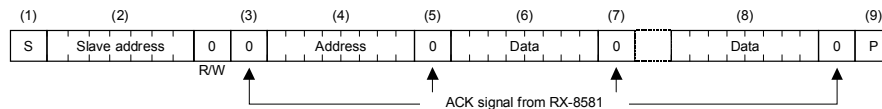

b. Address specification read sequence

After using write mode to write the address to be read, set read mode to read the actual data.

- (1) CPU transfers start condition [S].
- (2) CPU transmits the RA-8581's slave address with the R/W bit set to write mode.
- (3) Check for ACK signal from RA-8581.
- (4) CPU transfers address for reading from 8581.
- (5) Check for ACK signal from RA-8581.
- (6) CPU transfers RESTART condition [Sr] (in which case, CPU does not transfer a STOP condition [P]).
- (7) CPU transfers RA-8581's slave address with the R/W bit set to read mode.
- (8) Check for ACK signal from RA-8581 (from this point on, the CPU is the receiver and the RA-8581 is the transmitter).
- (9) Data from address specified at (4) above is output by the RA-8581.
- (10) CPU transfers ACK signal to RA-8581.
- (11) Repeat (9) and (10) if necessary. Read addresses are automatically incremented.
- (12) CPU transfers ACK signal for "1".
- (13) CPU transfers stop condition [P].

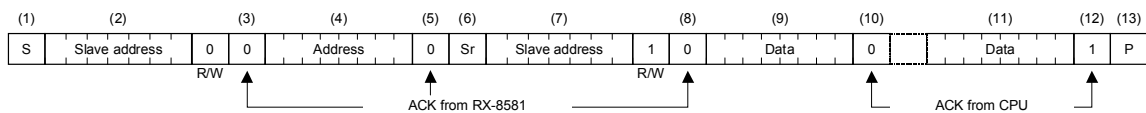

c. Read sequence when address is not specified

Once read mode has been initially set, data can be read immediately. In such cases, the address for each read operation is the previously accessed address + 1.

- (1) CPU transfers start condition [S].
- (2) CPU transmits the RA-8581's slave address with the R/W bit set to read mode.
- (3) Check for ACK signal from RA-8581 (from this point on, the CPU is the receiver and the RA-8581 is the transmitter).
- (4) Data is output from the RA-8581 to the address following the end of the previously accessed address.
- (5) CPU transfers ACK signal to RA-8581.
- (6) Repeat (4) and (5) if necessary. Read addresses are automatically incremented in the RA-8581.
- (7) CPU transfers ACK signal for "1".
- (8) CPU transfers stop condition [P].

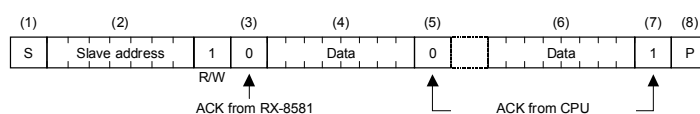

8.7. Backup and Recovery

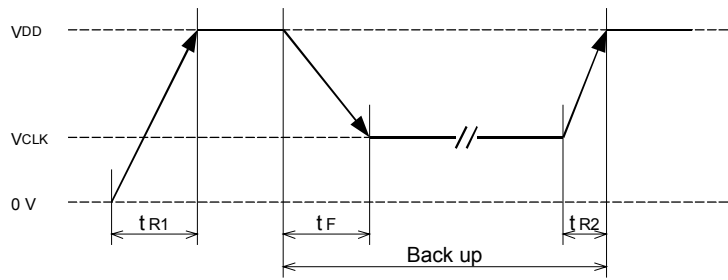

Item	Symbol	Min.	Typ.	Max.
Power supply drop time	t_F	2 μ s /V		
Initial power-up time	t_{R1}	1 μ s /V		10 ms /V
Clock maintenance power-up time	t_{R2}	1 μ s /V		

8.8. Connection with Typical Microcontroller

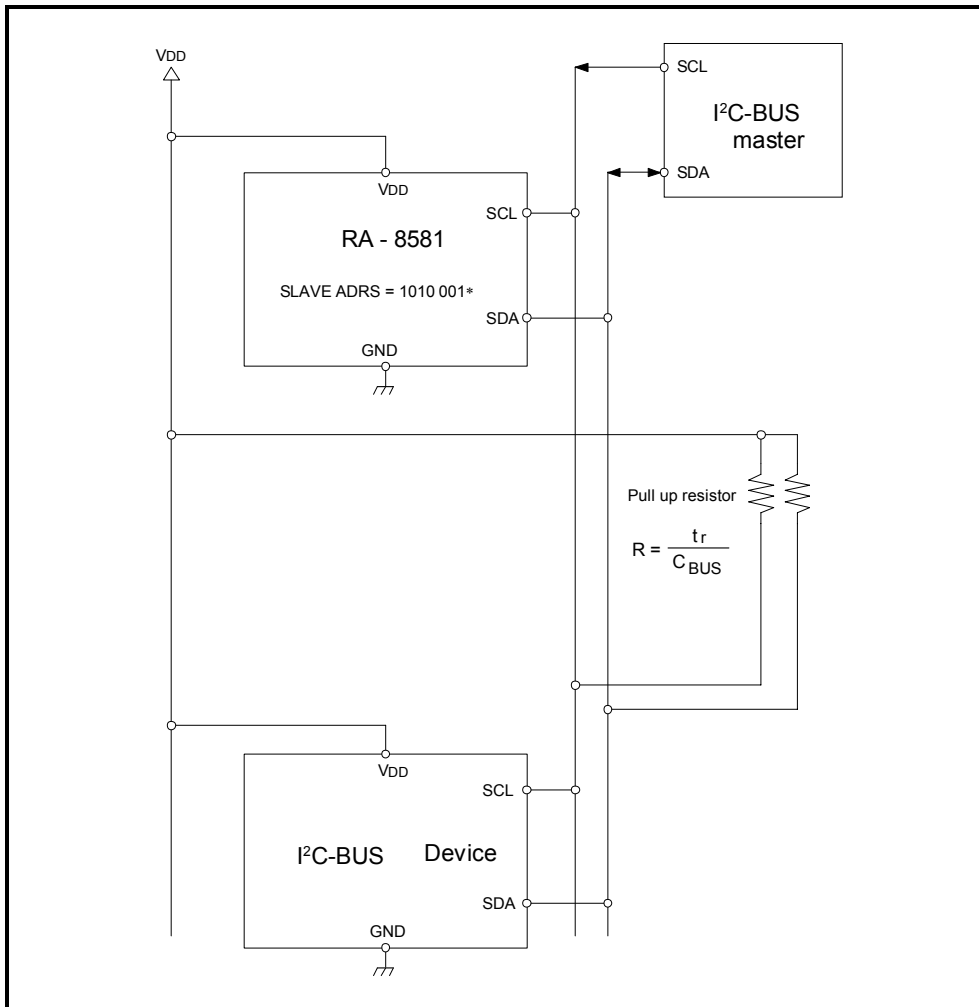

9. External Dimensions / Marking Layout

9.1. External dimensions

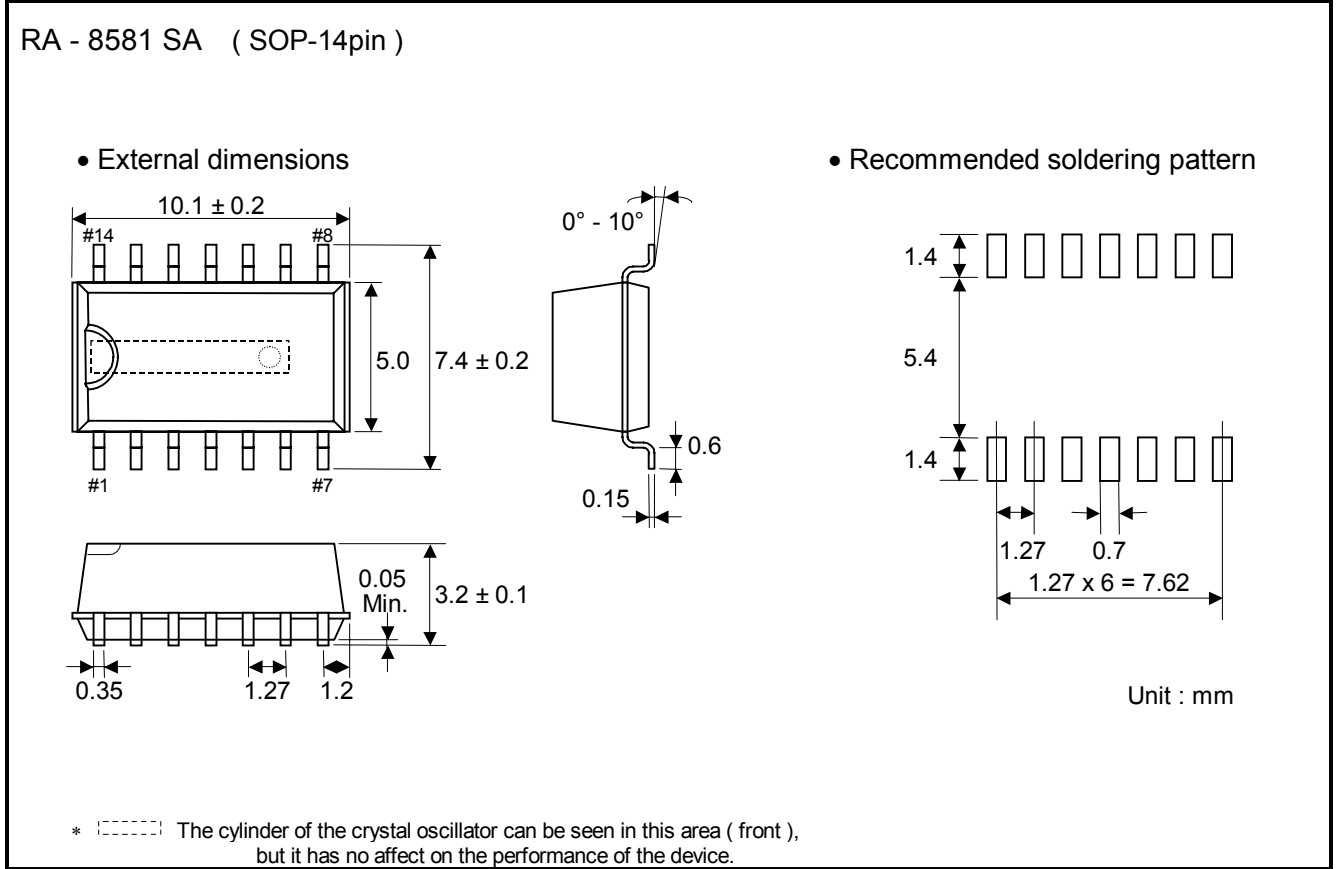

9.2. Marking layout

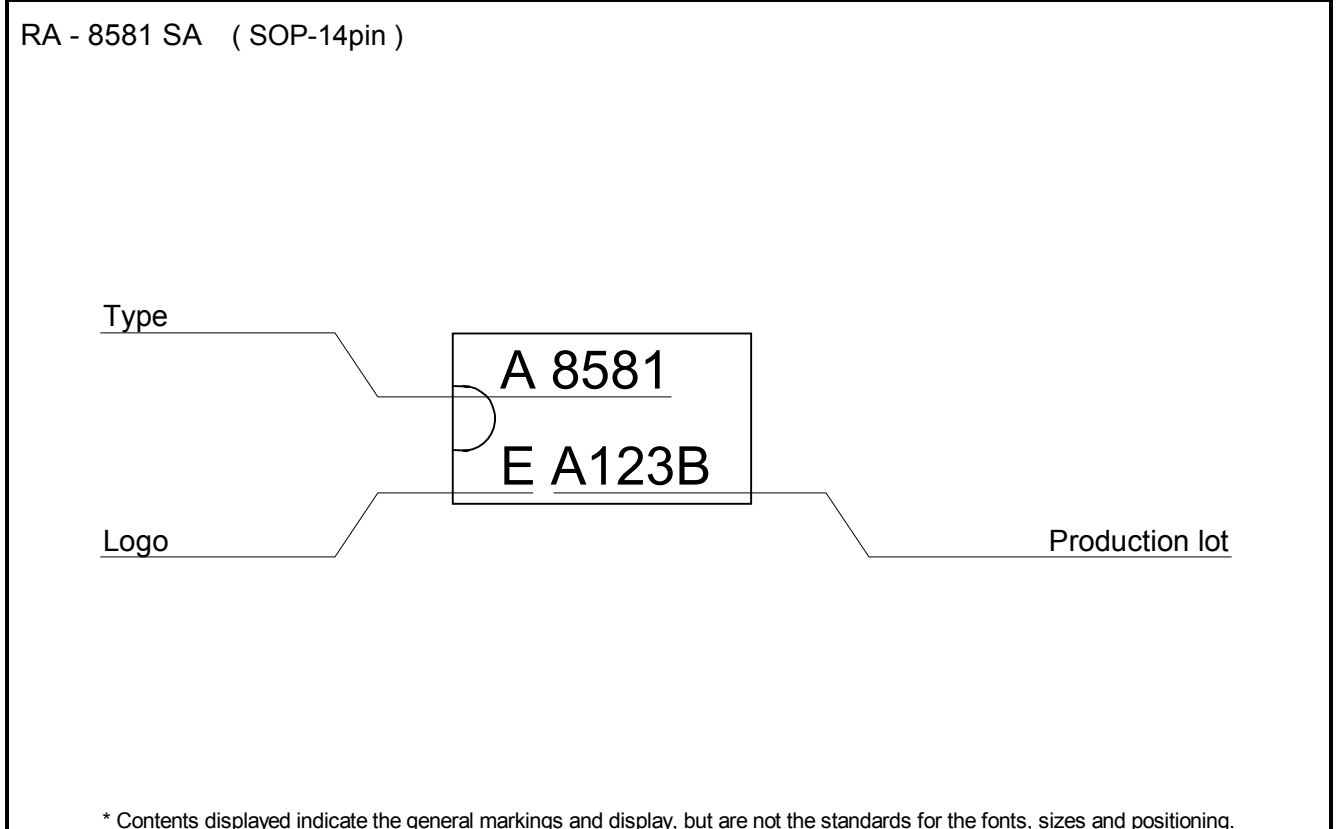

10. Reference Data

(1) Example of frequency and temperature characteristics

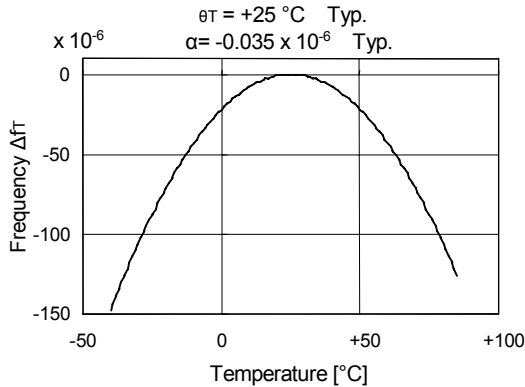

[Finding the frequency stability]

1. Frequency and temperature characteristics can be approximated using the following equations.

$$\Delta f_T = \alpha (\theta_T - \theta_x)^2$$

Δf_T : Frequency deviation in any temperature

α ($1 / ^\circ\text{C}^2$) : Coefficient of secondary temperature
 (-0.035 ± 0.005) $\times 10^{-6} / ^\circ\text{C}^2$

θ_T ($^\circ\text{C}$) : Ultimate temperature ($+25 \pm 5$ $^\circ\text{C}$)

θ_x ($^\circ\text{C}$) : Any temperature

2. To determine overall clock accuracy, add the frequency precision and voltage characteristics.

$$\Delta f/f = \Delta f/f_0 + \Delta f_T + \Delta f_V$$

$\Delta f/f$: Clock accuracy (stable frequency) in any temperature and voltage

$\Delta f/f_0$: Frequency precision

Δf_T : Frequency deviation in any temperature

Δf_V : Frequency deviation in any voltage

(2) Example of frequency and voltage characteristics

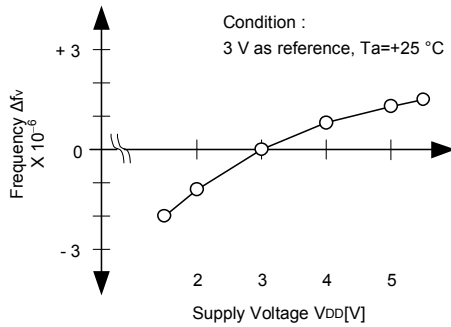

3. How to find the date difference

$$\text{Date difference} = \Delta f/f \times 86400 \text{ (seconds)}$$

* For example: $\Delta f/f = 11.574 \times 10^{-6}$ is an error of approximately 1 second/day.

(3) Current and voltage consumption characteristics

(3-1) Current consumption when non-accessed (i) when FOUT=OFF

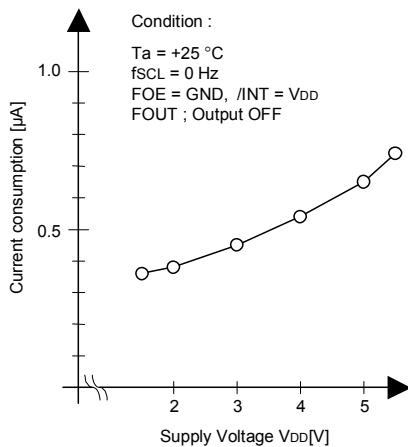

(3-2) Current consumption when non-accessed (ii) when FOUT=32.768 kHz

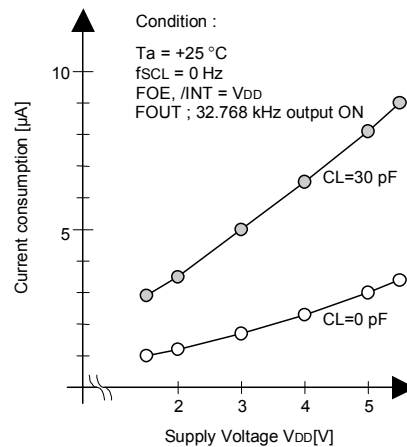

11. Application notes

1) Notes on handling

This module uses a C-MOS IC to realize low power consumption. Carefully note the following cautions when handling.

(1) Static electricity

While this module has built-in circuitry designed to protect it against electrostatic discharge, the chip could still be damaged by a large discharge of static electricity. Containers used for packing and transport should be constructed of conductive materials. In addition, only soldering irons, measurement circuits, and other such devices which do not leak high voltage should be used with this module, which should also be grounded when such devices are being used.

(2) Noise

If a signal with excessive external noise is applied to the power supply or input pins, the device may malfunction or "latch up." In order to ensure stable operation, connect a filter capacitor (preferably ceramic) of greater than 0.1F as close as possible to the power supply pins (between VDD and GNDs). Also, avoid placing any device that generates high level of electronic noise near this module.

* Do not connect signal lines to the shaded area in the figure shown in Fig. 1 and, if possible, embed this area in a GND land.

(3) Voltage levels of input pins

When the input pins are at the mid-level, this will cause increased current consumption and a reduced noise margin, and can impair the functioning of the device. Therefore, try as much as possible to apply the voltage level close to VDD or GND.

(4) Handling of unused pins

Since the input impedance of the input pins is extremely high, operating the device with these pins in the open circuit state can lead to unstable voltage level and malfunctions due to noise. Therefore, pull-up or pull-down resistors should be provided for all unused input pins.

2) Notes on packaging

(1) Soldering heat resistance.

If the temperature within the package exceeds +260 °C, the characteristics of the crystal oscillator will be degraded and it may be damaged. The reflow conditions within our reflow profile is recommended. Therefore, always check the mounting temperature and time before mounting this device. Also, check again if the mounting conditions are later changed.

* See Fig. 2 profile for our evaluation of Soldering heat resistance for reference.

(2) Mounting equipment

While this module can be used with general-purpose mounting equipment, the internal crystal oscillator may be damaged in some circumstances, depending on the equipment and conditions. Therefore, be sure to check this. In addition, if the mounting conditions are later changed, the same check should be performed again.

(3) Ultrasonic cleaning

Depending on the usage conditions, there is a possibility that the crystal oscillator will be damaged by resonance during ultrasonic cleaning. Since the conditions under which ultrasonic cleaning is carried out (the type of cleaner, power level, time, state of the inside of the cleaning vessel, etc.) vary widely, this device is not warranted against damage during ultrasonic cleaning.

(4) Mounting orientation

This device can be damaged if it is mounted in the wrong orientation. Always confirm the orientation of the device before mounting.

(5) Leakage between pins

Leakage between pins may occur if the power is turned on while the device has condensation or dirt on it. Make sure the device is dry and clean before supplying power to it.

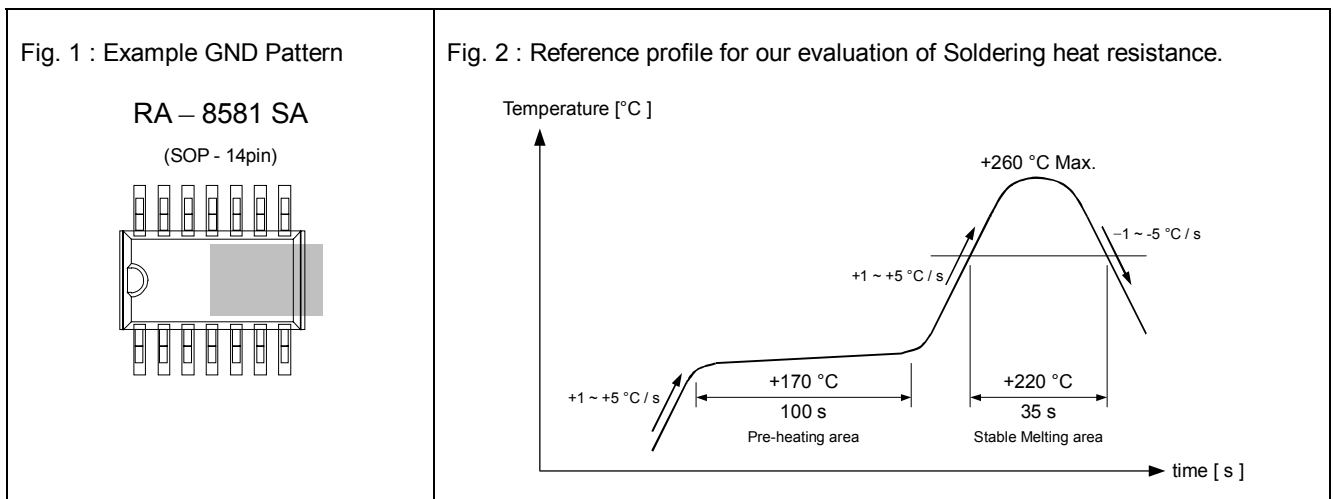

* In addition, please confirm the Notes of an individual specification.

Application Manual

AMERICA

EPSON ELECTRONICS AMERICA, INC.

HEADQUARTER	2580 Orchard Parkway, San Jose, CA 95131, U.S.A. Phone: (1)800-228-3964 (Toll free) : (1)408-922-0200 (Main) Fax: (1)408-922-0238 http://www.eea.epson.com
Atlanta Office	One Crown Center 1895 Phoenix Blvd. Suite 348 Atlanta, GA 30349 Phone: (1)800-228-3964 (Toll free) : (1)770-907-7667 (Main)
Boston Office	301 Edgewater Place, Ste. 120, Wakefield, MA 01880, U.S.A. Phone: (1)800-922-7667 (Toll free) : (1)781-246-3600 (Main) Fax: (1)781-246-5443
Chicago Office	1827 Walden Office Square. Suite 450 Schaumburg, IL 60173 Phone: (1)847-925-8350 Fax: (1)847 925-8965
El Segundo Office	1960 E. Grand Ave., 2nd Floor, El Segundo, CA 90245, U.S.A. Phone: (1)800-249-7730 (Toll free) : (1)310-955-5300 (Main) Fax: (1)310-955-5400

EUROPE

EPSON EUROPE ELECTRONICS GmbH

HEADQUARTER	Riesstrasse 15, 80992 Munich, Germany Phone: (49)-(0)89-14005-0 Fax: (49)-(0)89-14005-110 http://www.epson-electronics.de
-------------	-------------------------------------------------------------------------------------------------------------------------------------------------------------------------------

ASIA

EPSON (CHINA) CO., LTD.

7F, Jinbao Building No.89 Jinbao Street Dongcheng District, Beijing, China, 100005
Phone: (86) 10-8522-1199 Fax: (86) 10-8522-1120
<http://www.epson.com.cn>

Shanghai Branch

High-Tech Building, 900 Yishan Road Shanghai 200233, China
Phone: (86) 21-5423-5577 Fax: (86) 21-5423-4677

EPSON HONG KONG LTD.

20/F., Harbour Centre, 25 Harbour Road, Wanchai, Hong Kong
Phone: (852) 2585-4600 Fax: (852) 2827-2152
<http://www.epson.com.hk>

EPSON ELECTRONIC TECHNOLOGY DEVELOPMENT (SHENZHEN) CO., LTD.

12/F, Dawning Mansion, #12 Keji South Road, Hi-Tech Park, Shenzhen, China
Phone: (86) 755-26993828 Fax: (86) 755-26993838

EPSON TAIWAN TECHNOLOGY & TRADING LTD.

14F, No.7, Song Ren Road, Taipei 110
Phone: (886) 2-8786-6688 Fax: (886) 2-8786-6660
<http://www.epson.com.tw>

EPSON SINGAPORE PTE. LTD.

No 1 HarbourFront Place, #03-02 HarbourFront Tower One, Singapore 098633.
Phone: (65) 6586-5500 Fax: (65) 6271-3182
<http://www.epson.com.sg>

SEIKO EPSON CORPORATION KOREA Office

50F, KLI 63 Building, 60 Yoido-dong, Youngdeungpo-Ku, Seoul, 150-763, Korea
Phone: (82) 2-784-6027 Fax: (82) 2-767-3677
<http://www.epson-device.co.kr>

Gumi Branch Office

2F, Grand Bldg, 457-4, Songjeong-dong Gumi-City, Gyongsangbuk-Do,
730-090, Korea
Phone: (82) 54-454-6027 Fax: (82) 54-454-6093

EPSON TOYOCOM CORPORATION

Distributor